



COLLECTION 2024 / 25

Prosperplast®

color palette

S449	biały white
CY700	kremowy cream touch
7535C	beż senza
CY728	krem cream
7501U	słomkowy straw yellow
7502U	kawa z mlekiem milk coffee
7529U	mocca mocca
4985U	marsala marsala
7587U	rustykalna cegła rustic brick
R736	cegła brick
R624	terakota terracotta
7598U	miedziany copper
7601U	stal kortenowa corten steel
R222	brąz brown
440U	umbra umber
117U	musztardowy mustard
116C	żółty wiosenny spring yellow
R585	pomarańczowy orange
R200	pomarańczowy soczysty juicy orange
1788C	korale coral
3517U	czerwony retro retro red
7600C	palona cegła burnt brick
235C	fukcja fuchsia
5245U	jagodowy jasny light berry

3005U	blękitny light blue
5415C	niebieski skandynawski scandinavian blue
656U	lodowy szary ice gray
623U	szalwia sage
5615C	ziemisty zielony earth green
4193C	włoska zieleń verde
370U	oliwka olive
389U	limonka lime
G800	groszkowy green pea
G642	zielony green
361C	zielen wiosenna green spring
G851	zielony leśny forest green
2411U	zielona pinia pine green
309U	głębka oceanu ocean blue

S411	czarny black
B411	czarny beton black concrete
446U	węgiel carbon
419U	ciemny szary dark grey
S443	szary gray
433C	bazalt basalt
S433	antracytowy anthracite
S442	grafitowy graphite
426U	grafit graphite
405U	szary kamienny stone gray
425U	marengo marengo
422U	beton concrete
431UG	grys granitowy granite grit
7541U	granit granite
B68M	srebrny silver
4C	chłodny szary cool gray
429U	smooth gray smooth gray
443U	jasny szary light gray
S429	przezroczysty transparent



eco colors

S449W	biały ECO ECO white
7501W	słomkowy ECO ECO straw yellow
4665W	natura ECO ECO naturo
4625W	kawa ECO ECO coffee
2262W	zielony ECO ECO green
S433W	antracytowy ECO ECO anthracite



beton colors

CY700	kremowy cream touch
R624	terakota terracotta
422U	beton concrete
425U	marengo marengo
S433	antracytowy anthracite
B411	czarny beton black concrete

legend



PL symbol
EN symbol
DE symbol
CZ symbol



PL długość (mm)
EN length (mm)
DE länge (mm)
CZ délka



PL szerokość (mm)
EN width (mm)
DE breite (mm)
CZ šířka (mm)



PL wysokość (mm)
EN height (mm)
DE höhe (mm)
CZ výška (mm)



PL średnica (mm)
EN diameter (mm)
DE durchmesser (mm)
CZ průměr (mm)



PL pojemność wkładu/doniczki
EN capacity insert/flowerpot
DE Fassungsvermögen des Einsatzes/Planztopfs
CZ objem vkladu/květináče



PL pojemność
EN capacity
DE kapazität
CZ objem



PL system mechaniczny
EN mechanical system
DE mechanisches System
CZ mechanický systém



PL czas napełniania wodą
EN time filling water
DE Wasserfüllung Zeit
CZ čas naplnění vodou

legend



insert inside



outdoor



indoor



water flow



space for watering can



setup time



without tools



break - proof



frost - resistant



UV - resistant



light weight



stabilizing connector



padlock gap



SINCE
1993 Prosperplast®



We invite you to visit our Showroom – spanning over 400 m² and brimming with ideas, products, and inspirations. Our stylists have meticulously crafted a modern, minimalist interior with designated space for each product category. Our extensive assortment and diverse range guarantee continuous growth for you and your customers – our professional team oversees every detail! We are eagerly anticipating your visit!

showroom



[▶ Watch Video](#)



We set new trends

Prosperplast's mission is to develop practical, useful and aesthetic products. Our products have an advanced design, which is consistent with the trends in global markets.

We are design pioneers. The consecutive product lines set standards for the aesthetic appearance of homes and gardens. At the same time, our new collections aim to provide functionality for convenience.



Visit our website



Follow us
to find more!

instagram: @prosperplast_official
facebook: @prosperplast
prosperplast.pl



„Making the right and informed decisions - combined with production technologies and continuous innovation have led to Prosperplast's rapid growth.

We think forward and ahead of time, so we can develop the best products on the market.

With the growth of technology and continual evolution of consumer demands, our online presence had a makeover, so we can serve our B2B clients and help our B2C customers in a better online environment. Developing our new website we had three core objectives: to interest, inspire and educate. We can proudly say we have achieved all three goals and will continue growing our online platform to support our current and new customers on daily basis.

Our product offering is growing, so is our virtual world! Sign up to the Newsletter on our website to stay up to date with news from our Prosperplast world!"

●	Stand & Hanger Collection _____	8 - 11
	Bloomie Stand, Bloomie Hanger, Tol Stand, Showy Hanger	
	Lexo Style _____	12
●	Structural Effect Corten _____	13
	Tubus Corten, Tubus Slim Corten	
●	Beton Collection Line _____	14 - 25
	Mate Beton, Sierra Beton, Beton Bowl, Tubo Beton, Tubus Beton, Cube Beton, Urbi Beton, Gracia Beton	
●	Eco Wood Collection _____	26 - 41
	Lamia, Madera, Heos, Milly, Tubo, Sandy, Splofy, Ryfo, Rato, Urbi, Furu, Gracia, Tubus, Zanzi Basket, Zoe Basket, Uniqbo	
●	Regular Collection _____	42 - 97
	Mate, Lamia, Tubo, Gracia, Furu, Milly, Ryfo, Sandy, Splofy, Orient, Wheaty, Rato, Ratolla, Boardee, Lofly, Cascade Garden, Cascaden Garden Wall, Mini Cascade, Bloma, Respana, Urbi, Tubus, Lace, Coubi Orchid, Coubi, Coubi Herbal, Crown, Camelia, Balcony Can, Traditional Pots, Terra, Maze Cup	
●	Massive Collection _____	98 - 119
	Milly, Origina, Heos, Furu, Maze, Woode, Sunny, Decora, Sand, Sandy, Matuba, Classic, Classic Tower, Mobile Platform, Mobile Saucer	
●	Watering System _____	120 - 121





●	Raised Garden _____	122 - 149
	Respana Planter, Botanic, Bloomo, Respana Greenhouse, Respana Garden Tools, Respana Garden Sieve, Tomato Grower, Tomato Cup, Home Grower, Potato Grower, Planti, Grower, Floo Supports, Floo Tunnels, Combioliq, Combiosoil	
●	Watering Cans _____	150 - 155
	Tubo, Ibis, Jug, Spry, Eos, Koni, Giraffe, Coubi, Zebra, Aqua, Classico, Spring, Agra, Spring Rose, Gikabe	
●	Garden Cellar _____	156 - 159
	Ovo	
●	Gardening Tools _____	160 - 163
	Load&go, Weller, Smooth, Rake Loader, Bera Paw, Multi Holder, Focus, Expert, Focus Baby, Load Baby	
●	Living Style _____	164 - 175
	Woodebox, Boardebox, Boxe Matuba, Boxe Rato, Boxe Rato Plus, Boxe Board, Lottie, Uniqubo, Clubo, Zanzi Basket, Zoe Basket, Umbrella Base	
●	Palisade & Ground Grids _____	176 - 185
	Palisade, Palisade Border, Garden Stone, Garden Border, Garden Fence, Garden Line, Garden Classic, Drab, Base Woody, Border, Harpoon Peg, Sharkie, Plant, Pad, Easy Square, Mosaic	
●	Composter _____	186 - 197
	Compobox, Evogreen Vario, Compogreen Vario, Compogreen Woody, Evogreen, Compogreen, Compothermo, Biocompo, Ecocompo	
●	Bird Fedeers _____	198 - 199
	Birdyfeed Round, Birdyfeed Square, Birdyfeed Double	

JOIN THE NATURE



Elevate your plants with our four and three legged **Bloomie Stand**.

Industrial metal frame combined with classic, cylinder design of the plantpots will help your plants stand out and become an integral part of the space.



JOIN THE NATURE

bloomie stand & hanger

bloomie stand



Bloomie Stand

	mm	mm	mm	
IKD3L	540	490	805	3 x 4,0

S449 422U

Bloomie Stand

	mm	mm	mm	
IKD3H	420	395	1250	3 x 4,0

S449 422U

Bloomie Stand

	mm	mm	mm	
IKD4L	1250	550	815	4 x 4,0

S449 422U



Elevate your plants with a three legged Bloomie Stand. Three simple but elegant flowerpots complimented by an industrial metal frame. Each pot is placed on a different height making it look spacious and perfect for showcasing the beauty of each plant.



Bloomie Hanger

	mm	mm	mm	
IKBH600	270	235	645	4,0
IKBH600	270	235	845	4,0

S449 422U

Bloomie Hanger Set

	mm	mm	mm	
IKBH3S	270	235	645	3 x 4,0
	270	235	845	

S449 422U





JOIN THE NATURE
hanger & stand



Tol Stand

				
	mm	mm	mm	mm
IKF600	420	405	600	~200
IKF800	500	480	795	~260

S411

Multi-tiered, staggered-height plant stand with added base platforms. The collapsible metallic structure can be easily extended to create the perfect multi-tiered cascading display for any type of plants.



showy hanger



Showy Hanger

	mm	mm	mm	mm
IKSH1S*	306	164	506	~125÷160
IKSH1M**	386	209	656	~180÷220

S411



Showy Hanger

	mm	mm	mm	mm
IKSH2S*	297	209	256	~125÷160
IKSH2M**	377	276	325	~180÷220

S411



Showy Hanger

	mm	mm	mm	mm
IKSH3S*	226	170	306	~125÷160
IKSH3M**	386	215	406	~180÷220

S411



*Recommended flowerpot size 125-160 mm, depending on design
 **Recommended flowerpot size 180-220 mm, depending on design



JOIN THE NATURE
lexo large size



lexo

100 cm



packaging set

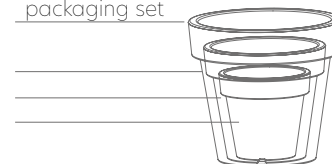

packaging set

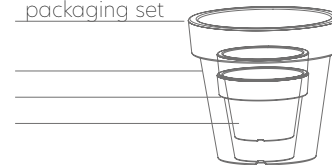

packaging set

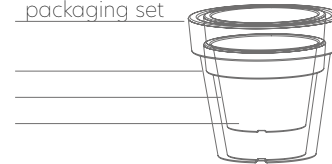

packaging set

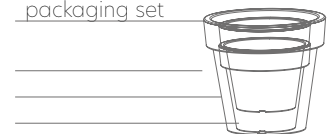

Lexo Round

	□	∅	↑	IT
		mm	mm	
DLR600		600	550	92
DLR800		800	740	212
DLR1000		1000	915	430

- S449
- 405U
- S433

Big size planter

The Lexo series is a response to the market demand for large-size flowerpots. They look great both in the garden and in urban spaces. Thanks to their very large capacity, you can even successfully grow trees in them. Extremely durable, resistant to all kinds of atmospheric factors.







EMBRACE NATURE
corten effect collection



Prosperplast®
corten





Tubus Slim Corten

			
	mm	mm	
DTUS150C	150	286	2,0/3,3
DTUS200C	200	381	4,0/8,0
DTUS250C	250	476	7,5/15,5
DTUS300C	300	572	15,0/27,0
DTUS400C	400	762	35,0/64,0

7601U



Tubus Corten

			
	mm	mm	
DTUB200C	200	187	3,5
DTUB250C	250	233	7,0
DTUB300C	300	280	12,0
DTUB400C	400	373	28,5

7601U

Sophisticated style combined with the dynamics of light. A unique industrial effect of the unique rawness of the Corten Steel. More over Tubus Slim Corten includes a liner which reduces the amount of soil needed. An irrigation system is optional.



The technological process may affect the colour of the product.



beton collection line

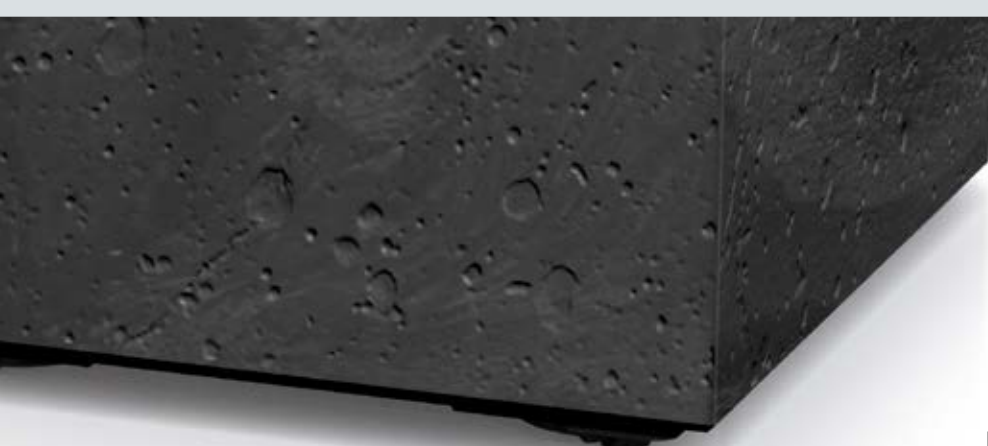

JOIN THE NATURE

beton effect

new

**Mate Beton Effect**

mm

mm



DMMA120E	119	109	0,9
DMMA140E	138	127	1,4
DMMA160E	158	145	2,0
DMMA180E	178	164	3,0
DMMA200E	198	182	4,1
DMMA240E	238	215	7,0
DMMA300E	295	266	13,6
DMMA350E	340	312	21,3
DMMA400E	385	354	31,0

422U

425U

S433

The Mate Beton Effect is a series of flowerpot characterized by a classic, smooth finish and a cylindrical shape that subtly widens towards the top. These models are distinguished by their exceptionally thin walls, which lend the flowerpots a sense of lightness and elegance.



The technological process may affect the colour of the product.

new



JOIN THE NATURE

beton collection line



Discover
the latest trends Sierra

beton effect



Convenient wheeled system for easy mobility.

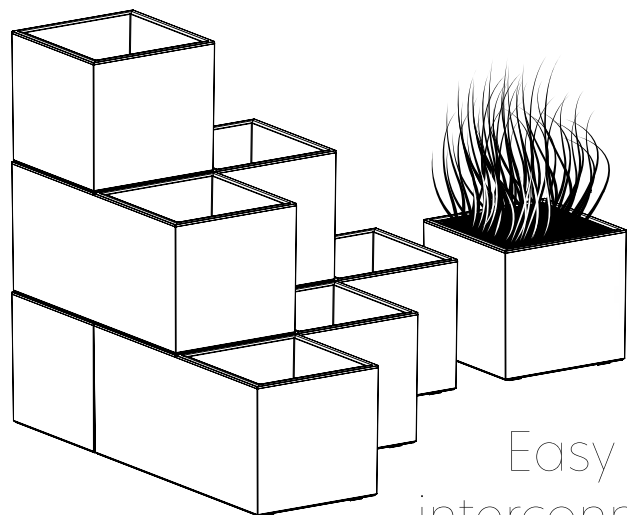

Easy module interconnectivity.



Compatible with Floo Supports p.141

new



Sierra Square Beton Effect

	mm	mm	mm	mm
DSI300E	288	288	290	13,1
DSI400E	385	385	370	31,5

425U S433 B411

new



Sierra Case Beton Effect

	mm	mm	mm	mm
DSI600E	577	288	290	26,2
DSI800E	770	385	370	63,0

425U S433 B411

The Sierra Square Beton Effect is a modern, square flowerpot with a distinctive texture that mimics concrete. This collection was designed with the capability to create layouts and separate areas, such as on terraces or balconies, thanks to a stacking system for the flowerpots. It is an ideal solution for decorating outdoor spaces like balconies and gardens, as well as larger indoor settings including restaurants, shops, and offices.

Sierra Case Beton Effect is a modern, elongated rectangular flowerpot with an internal partition dividing the space into two sections. Designed for creating arrangements and separating areas on terraces or balconies, this flowerpot features a stacking system. Perfect for outdoor and indoor decoration, it comes with internal liners for easy plant repotting and water drainage. Special wheels at the base facilitate the transportation of plants or the entire arrangement.







The technological process may affect the colour of the product.



JOIN THE NATURE
beton collection line



Beton Bowl

				
	mm	mm	mm	
DKB150	144	110	0,75	
DKB180	180	136	1,4	
DKB240	238	161	2,3	
DKB290	290	195	3,9	
DKB370	370	218	9,0	

422U B411



Metal Hanger

			
	mm	mm	mm
IWS	90	130	7



A ball-shaped pot with a pattern that gives it lightness, in the colour of natural concrete. Its form will surely make the plants look more attractive. Available in a standing and hanging version.



The technological process may affect the colour of the product.

beton effect



Tubo Beton Effect



	Ø mm	↑ mm	↓ mm
DPOS110E	108	95	0,7
DPOS130E	128	113	1,2
DPOS150E	148	130	1,8
DPOS180E	178	157	3,2
DPOS200E	199	177	4,6
DPOS240E	239	210	8,0
DPOS300E	292	257	14,5
DPOS350E	338	297	22,5
DPOS400E	390	342	35,0

422U S433



Tubo P Beton Effect



	Ø mm	↑ mm	↓ mm
DPOP110E	108	109	0,7
DPOP130E	128	128	1,2
DPOP150E	148	147	1,8
DPOP180E	178	175	3,2
DPOP200E	199	196	4,6
DPOP240E	239	231	8,0
DPOP300E	292	283	14,5
DPOP350E	338	326	22,5
DPOP400E	390	375	35,0

CY700 R624 422U

425U S433



Cylinder shape in a trendy beton effect finish that adds boldness to contemporary settings. Available with an attachable flowerpot base.



The technological process may affect the colour of the product.



JOIN THE NATURE
beton collection line



Tubus Beton Effect



	mm	mm	mm
DTUB200E	200	187	3,5
DTUB250E	250	233	7,0
DTUB300E	300	280	12,0
DTUB400E	400	373	28,5

422U 425U S433



Tubus Slim Beton Effect



	mm	mm	mm
DTUS150E	150	286	2,0/3,3
DTUS200E	200	381	4,0/8,0
DTUS250E	250	476	7,5/15,5
DTUS300E	300	572	15,0/27,0
DTUS400E	400	762	35,0/64,0

422U S433



Tubus Case Beton Effect



	mm	mm	mm	mm
DTUC400E	400	216	200	12,0
DTUC600E	600	324	300	38,6

422U S433



Cube Beton Effect



	mm	mm	mm
DCUB110E	110	97	0,6
DCUB140E	140	124	1,2
DCUB170E	170	150	2,2
DCUB200E	200	177	3,5
DCUB250E	250	221	7,0
DCUB300E	300	266	12,0
DCUB400E	400	354	29,0

422U S433

An elegant, distinctive and minimalist style of torn concrete. Simple design and timeless elegance. These are the main stylistic features of the Effect line.



The technological process may affect the colour of the product.

beton effect



Urbi Square Low Beton Effect



DURS240LE	240	240	235	7,5/10,0
DURS300LE	295	295	290	14,0 / 19,0

- CY700
- R624
- 422U
- 425U
- S433



Urbi Square Beton Effect



DURS125E*	126	126	200	- /2,0
DURS140E	140	140	265	2,0/4,0
DURS170E	170	170	325	3,0/7,2
DURS200E	195	195	375	5,0/11,4
DURS225E	220	220	420	8,0/16,3
DURS240E	238	238	449	7,5/19,0
DURS265E	265	265	500	11,0/26,6
DURS300E	295	292	550	14,0/35,0
DURS325E	325	325	610	21,0/49,0
DURS400E	400	400	750	37,0/91,5

- 422U
- 425U
- S433



Urbi Round Beton Effect



DURO250E	250	250	7,5 / 9,0
DURO300E	300	295	15,0/17,0

- CY700
- R624
- 422U
- 425U
- S433

Classic square form enriched by the contemporary beton effect finish. Available in a low and tall version to fit individual needs of the users. Equipped with an insert protecting against soil pouring out.



The technological process may affect the colour of the product.



JOIN THE NATURE
beton collection line



Urbi Case Beton Effect

	← mm	↘ mm	↑ mm	📏
DUC400E	395	185	195	8,0/12,0
DUC600E	580	180	195	12,0/18,0
DUC800E	770	235	246	27,0/40,0
CY700	R624	422U		
425U	S433			



Urbi Case Beton Effect W

	← mm	↘ mm	↑ mm	📏
DUC400EW	395	185	195	8,0/12,0
DUC600EW	580	180	195	12,0/18,0
CY700	R624	422U		
425U	S433			



Urbi Case Beton Effect M

	← mm	↘ mm	↑ mm	📏
DUC800ME	770	235	406	27,0/72,0
CY700	R624	422U		
425U	S433			



Urbi Case Beton Effect T

	← mm	↘ mm	↑ mm	📏
DUC600TE*	580	180	498	12,0/44,0
DUC800TE**	770	235	686	27,0/100
CY700	R624	422U		
425U	S433			

* 1 stabilizer included
** 2 stabilizers included



The technical specifications may affect the calculation of the product.



Urbi Case Beton Effect N



DUC800NE 770 235 300 27,0/40,0

422U 425U S433

Elevated by wooden looking legs Urbi Case N will add a contemporary and timeless styling to floor standing flower arrangements, indoor and outdoor. Equipped with an insert protecting against soil pouring out.



The technological process may affect the colour of the product.



JOIN THE NATURE
beton collection line



Gracia Square Beton Effect

	mm	mm	mm	
DGQL240E	240	240	187	6,00
DGQL300E	290	290	220	11,00
DGQL400E	390	390	270	25,00

CY700 422U S433



Gracia Case Beton Effect

	mm	mm	mm	
DGCL400E	390	195	187	8,50
DGCL600E	580	240	235	19,50

CY700 422U S433



Functional form enriched by the contemporary beton effect finish. Gracia is perfect for seedling plants and by added wooden looking legs, ideal for elevating green displays from floor level indoor and outdoor.



The technological process may affect the colour of the product.

beton effect



Gracia Low Beton Effect

	mm	mm	L
DGRL240LE	235	155	3,80
DGRL300LE	285	177	6,80
DGRL400LE	380	207	14,30

CY700 422U S433



Gracia Beton Effect

	mm	mm	L
DGRL200E	200	174	3,0
DGRL240E	238	187	5,10
DGRL300E	290	220	9,80
DGRL350E	339	240	13,80
DGRL400E	390	270	21,50

CY700 422U S433



Gracia Tubus Beton Effect

	mm	mm	L
DGTL300LE	298	285	14,00

CY700 422U S433



Gracia Tubus Slim Beton Effect

	mm	mm	L
DGTL200E	195	365	7,50
DGTL240E	239	445	14,50

CY700 R624 422U
425U S433

Concrete finish and simple form of the Gracia Beton Effect flowerpot follows the newest design trends. By adding wooden looking legs we brought classic touch to its contemporary design.



The technological process may affect the colour of the product.



eco-friendly collection

Up to 33% of
natural wood



Advanced technology of recycle natural waste obtained as a result of wood processing allows us to use it as a unique and original component for production of the Eco Wood collection.



new



flat grooves



Lamia Round ECO Wood

	 mm	 mm	 mm
DLAM120W	119	99	0,8
DLAM140W	138	115	1,3
DLAM160W	158	132	1,9
DLAM180W	178	149	2,8
DLAM200W	198	173	3,9
DLAM240W	238	205	6,8
DLAM300W	295	246	12,8
DLAM350W	340	284	19,7
DLAM400W	385	325	29,0



Lamia Round ECO Wood is an elegant round planter with distinctive vertical, flat grooves that give it a unique character and elegance. This collection stands out with its wider base and shorter walls.



The technological process may affect the colour of the product.



new

JOIN THE NATURE



new



JOIN THE NATURE
ECO wood collection

Easy module interconnectivity.



Convenient wheeled system
for easy mobility.



Compatible with Floo Supports p.141

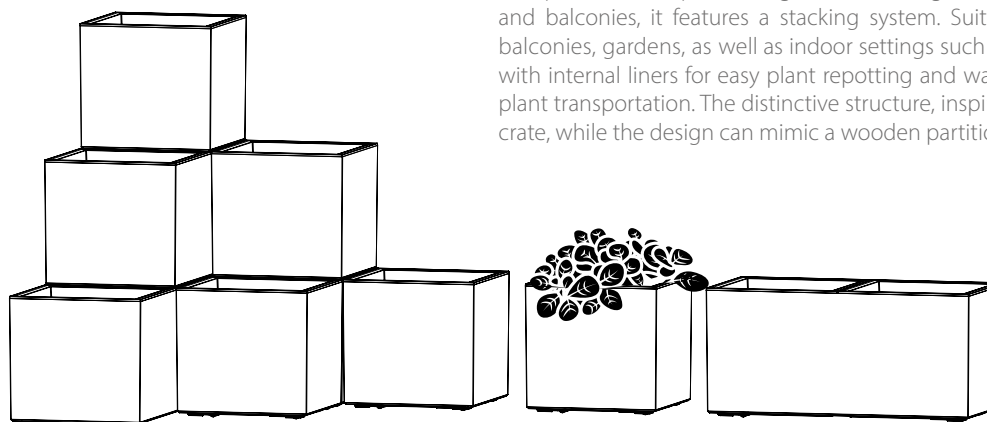

new

Madera Square ECO Wood

	← mm	↗ mm	↑ mm	🚗
DMA300W	288	288	290	13,1
DMA400W	385	385	370	31,5

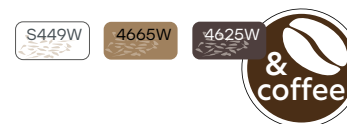

new

Madera Case ECO Wood

	← mm	↗ mm	↑ mm	🚗
DMA600W	577	288	290	26,2
DMA800W	770	385	370	63,0



Madera Square ECO Wood is a modern, square flowerpot in the shape of a cube, designed for creating compositions and delineating areas on terraces and balconies. Specially designed features facilitate the stacking of planters. It is ideal for decorating outdoor and indoor spaces such as restaurants, shops, or offices. It comes with an internal liner for easy plant repotting and water drainage, while special wheels aid in transporting tall plants or entire arrangements.

Madera Case Eco Wood is a modern rectangular flowerpot with an internal partition dividing the space into two parts. Designed for creating compositions and separating areas on terraces and balconies, it features a stacking system. Suitable for decorating outdoor spaces like balconies, gardens, as well as indoor settings such as restaurants, shops, or offices. Equipped with internal liners for easy plant repotting and water drainage. Wheels at the base facilitate plant transportation. The distinctive structure, inspired by natural wood, resembles a wooden crate, while the design can mimic a wooden partition.



The technological process may affect the colour of the product.



JOIN THE NATURE
ECO wood collection



eco wood



Heos ECO Wood



DBHEM300W	298	230	8,0/10,0
DBHEM400W	395	302	18,0/25,0
DBHEM470W	469	360	31,0/47,0
DBHEM570W	569	435	56,0/84,0



Heos ECO Wood



DBHEK400W	370	230	8,0/18,0
DBHEK440W	436	270	11,0/32,0



JOIN THE NATURE





eco-friendly product easier biodegradability



The technological process may affect the colour of the product.



Milly Round ECO Wood

	 mm	 mm	 mm	
DMI110W	109	95	0,7	
DMI130W	129	114	1,2	
DMI150W	146	129	1,7	
DMI170W	169	149	2,7	
DMI200W	196	173	4,0	
DMI240W	236	208	7,0	
DMI300W	292	258	13,5	
DMI350W	342	302	21,5	
DMI400W	390	345	32,0	

4665W

A stylish flowerpot with a unique pattern of vertical stripes, adding elegance and modernity. Its unique design fits many different furnishing styles. Made of a material containing up to 33% wood.



The technological process may affect the colour of the product.







JOIN THE NATURE
ECO wood collection



eco wood







Tubo ECO Wood

				
	mm	mm	mm	
DPOS110W	108	95	0,7	
DPOS130W	128	113	1,2	
DPOS150W	148	130	1,8	
DPOS180W	178	157	3,2	
DPOS200W	199	177	4,6	
DPOS240W	239	210	8,0	
DPOS300W	292	257	14,5	
DPOS350W	338	297	22,5	
DPOS400W	390	342	35,0	



Tubo P ECO Wood

				
	mm	mm	mm	
DPOP110W	108	109	0,7	
DPOP130W	128	128	1,2	
DPOP150W	148	147	1,8	
DPOP180W	178	175	3,2	
DPOP200W	199	196	4,6	
DPOP240W	239	231	8,0	
DPOP300W	292	283	14,5	
DPOP350W	338	326	22,5	
DPOP400W	390	375	35,0	



Cylinder shape made from material that contains up to 33% of natural wood, which results in easier biodegradability. Simple form of the Tubo P ECO Wood plantpot adds calmness to modern spaces. Available with an attachable plantpot base.

eco-friendly product
easier biodegradability



The technological process may affect the colour of the product.



Sandy Round ECO Wood

	□	∅	↑	Ⓛ
	mm	mm	mm	
DSR130W	128	111	0,9	
DSR160W	158	138	1,7	
DSR190W	189	165	3,0	
DSR220W	225	192	5,0	
DSR260W	262	222	7,9	

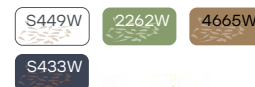

Openwork Sandy ECO Wood flowerpot that interestingly displays its structure. Equipped with an insert protecting against the soil pouring out. The collection in delicate neutral colours will adorn any space.



Splofy ECO Wood

	□	∅	↑	Ⓛ
	mm	mm	mm	
DSP130W	130	108	0,9	
DSP160W	157	132	1,7	
DSP190W	187	158	3,0	
DSP220W	218	184	5,0	
DSP260W	259	220	8,0	



A round flowerpot from the Splofy ECO Wood collection, whose texture gives the impression of a pleasant to the touch. A collection in delicate, neutral colours.



The technological process may affect the colour of the product.



JOIN THE NATURE
ECO wood collection



eco wood



Ryfo ECO Wood

	∅ mm	↓ mm	∩ mm
DRF110W	107	91	0,6
DRF130W	126	108	1,0
DRF150W	146	126	1,6
DRF170W	168	147	2,5
DRF200W	195	170	4,0



Ryfo N ECO Wood

	∅ mm	↓ mm	∩ mm
DRF110NW	107	105	0,6
DRF130NW	126	125	1,0
DRF150NW	145	145	1,6
DRF170NW	168	170	2,5
DRF200NW	195	194	4,0



A round flowerpot that, by its interesting texture, breaks the monotony in any space. Horizontal lines formed on the flowerpot make it look extraordinary. Moreover, the collection contains up to 33% of natural wood, which results in easier biodegradability.



The technological process may affect the colour of the product.



Urbi Square ECO Wood



	mm	mm	mm	mm
DURS200W	195	195	375	5,0/11,4
DURS240W	240	240	449	7,5/19,0
DURS300W	295	295	550	14,0/35,0

S449W 4665W



Rato Square ECO Wood



	mm	mm	mm	mm
DRTS200W	200	200	376	5,0/11,4
DRTS240W	240	240	450	7,5/19,0
DRTS300W	290	290	550	14,0/35,0

S449W 4665W



Thanks to the use of natural wood for production, our flowerpots combine a natural beauty and timeless elegance. Stylish and elegant Urbi ECO Wood range now contains up to 33% of the natural wood. A simple design dedicated for minimalist arrangements.

Tall Rato Square ECO Wood plant pot with texture closely resembling natural rattan weave, in a classical, pure form, enables you to freely create unique interiors and spaces around the home.



The technological process may affect the colour of the product.



JOIN THE NATURE
ECO wood collection



eco wood



Furu Square Low ECO Wood

	mm	mm	mm	mm
DFS240W	240	240	235	7,5/10,0
DFS300W	295	295	290	14,0/19,0

Furu Square ECO Wood

	mm	mm	mm	mm
DFSH200W	200	200	380	5,0/11,4
DFSH240W	240	240	450	7,5/19,0
DFSH265W	265	265	500	11,0/26,6
DFSH300W	295	295	550	14,0/35,0
DFSH350W	345	345	660	24,0/60,0
DFSH400W	395	395	755	37,0/91,5



Earthy look achieved by the wooden looking structure adds bohemian styling to shelf, table and floor standing displays. Flowerpot in a square shape that contains up to 33% of natural wood. Available in a low and tall version to fit individual needs of the users.



The technological process may affect the colour of the product.



Furu Round ECO Wood



DFR250W	250	247	7,5/9,0
DFR300W	300	294	15,0/17,0

S449W

4665W

4625W



Furu Slim ECO Wood



DFRH250W	250	480	7,5/15,5
DFRH300W	300	575	15,0/27,0

S449W

4665W

4625W



Earthy look achieved by the wooden looking structure adds bohemian styling to shelf, table and floor standing displays. Flowerpot in a round shape that contains up to 33% of natural wood. Available in a low and tall version to fit individual needs of the users.



Furu ECO Wood



DFUR240W	236	195	5,0
DFUR300W	290	240	9,5
DFUR400W	395	320	26,0

4665W

The Furu ECO Wood is a flowerpot in a classic form with a rounded bottom raised on legs and a wavy surface.



The technological process may affect the colour of the product.



JOIN THE NATURE
ECO wood collection



eco wood



Gracia Square ECO Wood

	← mm	↘ mm	↑ mm	📄
DGQL240W	240	240	187	6,00
DGQL300W	290	290	220	11,00
DGQL400W	390	390	270	25,00

S449W 4665W S433W



Gracia Case ECO Wood

	← mm	↘ mm	↑ mm	📄
DGCL400W	390	195	187	8,50
DGCL600W	580	240	235	19,50

S449W 4665W S433W



Functional form enriched by the earthy finish. Gracia is perfect for seedling plants and by added wooden looking legs, ideal for elevating green displays from floor level indoor and outdoor.



The technological process may affect the colour of the product.



Gracia Low ECO Wood



	mm	mm	mm
DGRL240LW	235	155	3,80
DGRL300LW	285	177	6,80
DGRL400LW	380	207	14,30



Gracia ECO Wood



	mm	mm	mm
DGRL200W	200	174	3,0
DGRL240W	238	187	5,10
DGRL300W	290	220	9,80
DGRL350W	339	240	15,50
DGRL400W	390	270	21,50



Gracia Tubus ECO Wood



	mm	mm	mm
DGTL300LW	298	285	14,00



Simple form of the Gracia ECO Wood flowerpot ensures it can fit into all spaces. By adding wooden looking legs we brought classic touch to its contemporary design, making the Gracia series timeless.



Gracia Tubus Slim ECO Wood



	mm	mm	mm
DGTL200W	195	365	7,50
DGTL240W	239	445	14,50



The technological process may affect the colour of the product.



JOIN THE NATURE
ECO wood collection



eco wood



Tubus ECO Wood



DTUB200W	200	187	3,5
DTUB250W	250	233	7,0
DTUB300W	300	280	12,0



Tubus Slim ECO Wood



DTUS200W	200	381	4,0/8,0
DTUS250W	250	476	7,5/15,5
DTUS300W	300	572	15,0/27,0



An elegant, distinctive and minimalist style of torn ECO Wood. Simple design and timeless elegance. These are the main stylistic features of the new Eco line. Moreover Tubus Slim Eco Wood includes a liner which reduces the amount of soil needed. An irrigation system is optional.



The technological process may affect the colour of the product.



Zanzi Basket ECO Wood



IKPIR 380W	374	402	25
IKPIR 430W	430	463	40



Zoe Basket ECO Wood



IKPIO370W	364	359	25
IKPIO430W	419	408	40



The harmony of proportions and elegant shape make this line an ideal complement for every interior and house surroundings. They are made of a lightweight, yet durable material, easy to clean and weatherproof.



Uniqubo ECO Wood



IKUB55TW	447	450	55
----------	-----	-----	----



The technological process may affect the colour of the product.



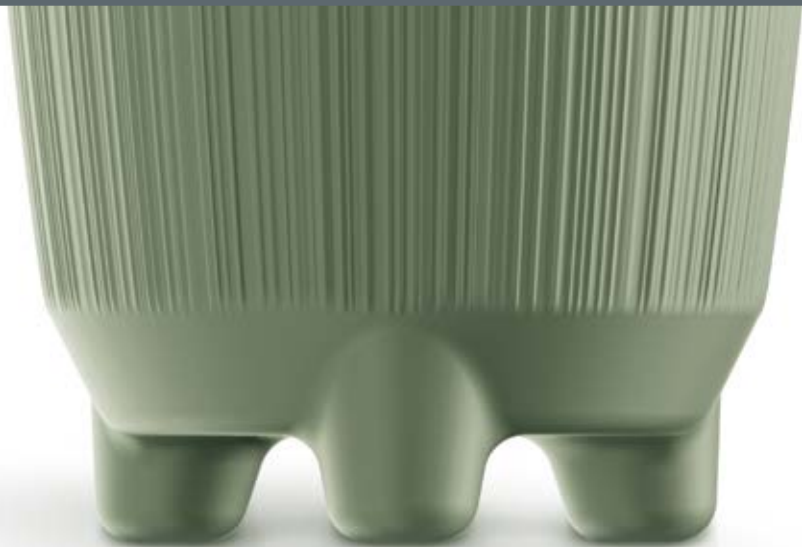

regular collection



new



Mate

	 mm	 mm	
DMMA120	119	109	0,9
DMMA140	138	127	1,4
DMMA160	158	145	2,0
DMMA180	178	164	3,0
DMMA200	198	182	4,1
DMMA240	238	215	7,0
DMMA300	295	266	13,6
DMMA350	340	312	21,3
DMMA400	385	354	31,0

- S449
- 4985U
- 7600C
- 2411U
- 443U
- S433
- 446U

The Mate is a series of flowerpots characterized by a classic, smooth finish and a cylindrical shape that subtly widens towards the top. These models are distinguished by their exceptionally thin walls, which lend the planters a sense of lightness and elegance.





JOIN THE NATURE
regular collection





JOIN THE
NATURE

regular

new



Lamia

			
	mm	mm	mm
DLAM120	119	99	0,8
DLAM140	138	115	1,3
DLAM160	158	132	1,9
DLAM180	178	149	2,8
DLAM200	198	173	3,9
DLAM240	238	205	6,8
DLAM300	295	246	12,8
DLAM350	340	284	19,7
DLAM400	385	325	29,0

- S449
- 443U
- 2411U
- S433

Lamia is an elegant round planter with distinctive vertical, flat grooves that give it a unique character and elegance. This collection stands out with its wider base and shorter walls.





Tubo

	Ø	↑	↓
	mm	mm	mm
DPOS110	108	95	0,7
DPOS130	128	113	1,2
DPOS150	148	130	1,8
DPOS180	178	157	3,2
DPOS200	199	177	4,6
DPOS240	239	210	8,0
DPOS300	292	257	14,5
DPOS350	338	297	22,5
DPOS400	390	342	35,0
DPOS480	-	-	-
DPOS600	-	-	-

- S449
- 443U
- 2411U
- S433

January 2025



Tubo P

	Ø	↑	↓
	mm	mm	mm
DPOP110	108	109	0,7
DPOP130	128	128	1,2
DPOP150	148	147	1,8
DPOP180	178	175	3,2
DPOP200	199	196	4,6
DPOP240	239	231	8,0
DPOP300	292	283	14,5
DPOP350	338	326	22,5
DPOP400	390	375	35,0

- S449
- 443U
- 2411U
- 117U
- 4985U
- S433
- 419U
- DPOP480
- DPOP600
- S449
- 443U
- 2411U
- S433
- 419U



Tubo PM

	Ø	↑	↓
	mm	mm	mm
DPOD110	108	109	0,7
DPOD130	128	128	1,2
DPOD150	148	147	1,8
DPOD180	178	175	3,2
DPOD200	199	196	4,6
DPOD240	239	231	8,0
DPOD300	292	283	14,5
DPOD350	338	326	22,5
DPOD400	390	375	35,0

Saucer always in 4665W

- S449
 - 2411U
 - S433
- 

Cylinder shape in a comforting matt finish. Simplicity of the Tubo P flowerpot tones down busy arrangements. Available with an attachable plantpot base.





JOIN THE NATURE
regular collection



Gracia Square

	← mm	↘ mm	↑ mm	📄
DGQL240	240	240	187	6,00
DGQL300	290	290	220	11,00
DGQL400	390	390	270	25,00

- S449
- 5615C
- 443U
- S433



Gracia Case

	← mm	↘ mm	↑ mm	📄
DGCL400	390	195	187	8,50
DGCL600	580	240	235	19,50

- S449
- 5615C
- 443U
- S433





Gracia Standard Low

	mm	mm	mm
DGRS240L	235	110	3,80
DGRS300L	285	132	6,80
DGRS400L	380	150	14,30

- S449
- 5615C
- 443U
- S433



Gracia Standard

	mm	mm	mm
DGRS240	238	142	5,10
DGRS300	290	175	9,80
DGRS350	339	183	13,8
DGRS400	390	212	21,50

- S449
- 5615C
- 443U
- S433



Gracia Tubus Slim

	mm	mm	mm
DGTL200	195	365	7,50
DGTL240	239	445	14,50

- S449
- 5615C
- 443U
- S433



Gracia Low Beton Effect

	mm	mm	mm
DGRL240L	235	155	3,80
DGRL300L	285	177	6,80
DGRL400L	380	207	14,30

- S449
- 5615C
- 443U
- S433



Gracia Beton Effect

	mm	mm	mm
DGRL200	200	174	3,0
DGRL240	238	187	5,10
DGRL300	290	220	9,80
DGRL350	339	240	13,80
DGRL400	390	270	21,50

- S449
- 5615C
- 443U
- S433



Gracia Tubus Beton Effect

	mm	mm	mm
DGTL300L	298	285	14,00

- S449
- 5615C
- 443U
- S433

Thanks to the smooth finish and simple form we have achieved a contemporary design in our Gracia series. Gracia complements minimalistic spaces and tones down busy arrangements.

Tall flowerpot that by wooden looking legs elevates flowers and plants for greater eye-catching effect in modern interiors, balcony and garden scapes.





Discover





Furu collection



JOIN THE NATURE
regular collection





Furu Round

				
	mm	mm		
DFR250	250	247	7,5/ 9,0	
DFR300	300	294	15,0/17,0	

- S449
- 5615C
- 5415C
- 422U
- S433



Furu Slim

				
	mm	mm		
DFRH250	250	480	7,5/15,5	
DFRH300	300	575	15,0/27,0	

- S449
- 5615C
- 5415C
- 422U
- S433







Furu Square Low

					
	mm	mm	mm		
DFS240	240	240	235	7,5/10,0	
DFS300	295	295	290	14,0/19,0	

- S449
- 5615C
- 5415C
- 422U
- S433



Furu Square

					
	mm	mm	mm		
DFSH200	200	200	380	5,0/11,4	
DFSH240	240	240	450	7,5/19,0	
DFSH265	265	265	500	11,0/26,6	
DFSH300	295	295	550	14,0/35,0	
DFSH350	345	345	660	24,0/60,0	
DFSH400	395	395	755	37,0/91,5	

- S449
- 5615C
- 5415C
- 422U
- S433



Classic round shapes combined with playful, lined surface make the Furu Collection sturdy yet elegant and classic. Available in a low and tall version to fit individual needs of the users. Equipped with an insert protecting against soil pouring out.

Classic square shapes combined with playful, lined surface make the Furu Collection sturdy yet elegant and classic. Available in a low and tall version to fit individual needs of the users. Equipped with an insert protecting against soil pouring out.



JOIN THE NATURE
regular collection



Furu Case

	←→ mm	↙↘ mm	↑↓ mm	♻️
DFC400	395	185	195	8,0/12,0
DFC600	580	180	195	12,0/18,0

S449 422U S433



Furu Case M

	←→ mm	↙↘ mm	↑↓ mm	♻️
DFC800M	770	235	406	27,0/72

S449 422U S433



regular



Furu Case W

	←→ mm	↙↘ mm	↑↓ mm	♻️
DFC400W	395	185	195	8,0/12,0
DFC600W	580	180	195	12,0/18,0

S433



Furu Case T

	←→ mm	↙↘ mm	↑↓ mm	♻️
DFC600T*	580	180	498	12,0/44,0
DFC800T**	770	235	686	27,0/100

S449 422U S433

A playful twist on a classic case. Lined surface make the Furu Collection sturdy yet elegant. Available in a variety of sizes and combinations to fit individual needs of the users. Each Furu case is equipped with an insert protecting against soil pouring out.





Furu

	∅ mm	↑ mm	↓ mm
DF0150	145	116	1,0
DF0170	162	138	1,6
DF0200	193	167	2,8
DF0240	235	207	5,1
DF0300	295	248	10,2

S449 S433



Furu Round

	∅ mm	↑ mm	↓ mm
DFA120	122	122	1,0
DFA145	147	148	1,7
DFA175	178	180	3,0

S449 S433



Furu

	∅ mm	↑ mm	↓ mm
DFUR240	236	195	5,0
DFUR300	290	240	9,5
DFUR400	395	320	26,0

S449 5615C 443U
S433



Furu Case

	← mm	↗ mm	↑ mm
DFA275	277	147	148 4,0

S449 S433

Original design of the Furu collection will adorn any space. Unique surface enriched with delicate and undulating grooves make this pot a very elegant decoration.





new



Milly Round

	mm	mm	mm
DMIG150	146	215	-
DMIG190	188	277	-

S449	4985U	443U
S433	2411U	446U

new



Milly Round

	mm	mm	mm
DMIL190	188	226	-

S449	4985U	443U
S433	2411U	446U



Milly Round is an elegant round flowerpot with vertical, rounded grooves that give it a unique character. It features a classic cylindrical shape with a visible cut in the narrower part at the base, creating a ring-like effect.

Its timeless design and muted colors allow it to blend seamlessly into modern arrangements, adding a designer touch to interiors, gardens, or terraces.



JOIN THE NATURE
regular collection



Milly Round

	Ø mm	↑ mm	↓ mm
DMI110	109	95	0,7
DMI130	129	114	1,2
DMI150	146	129	1,7
DMI170	169	149	2,7
DMI200	196	173	4,0
DMI240	236	208	7,0
DMI300	292	258	13,5
DMI350	342	302	21,5
DMI400	390	345	32,0

- S449
- 4985U
- 443U
- S433
- 2411U
- 446U
- 309U

Milly Round

	Ø mm	↑ mm	↓ mm
DMIN130	128	138	-
DMIN150	146	157	-
DMIN170	168	181	-
DMIN200	195	210	-

- S449
- 4985U
- 443U
- S433
- 2411U
- 446U

A stylish flowerpot with a unique pattern consisting of vertical stripes that attracts attention and gives the flowerpot a unique character. Its classic form and subdued colours make it a perfect fit for many modern arrangements, introducing a trendy accent to interiors or open spaces of a garden or terrace.



JOIN THE
NATURE



JOIN THE NATURE
regular collection



Ryfo

	∅ mm	↓ mm	⊞
DRF70	69	58	0,16
DRF90	88	75	0,34
DRF110	107	91	0,6
DRF130	126	108	1,0
DRF150	146	126	1,6
DRF170	168	147	2,5
DRF200	195	170	4,0

- S449
- 5615C
- 5415C
- 443U
- S433

Ryfo N

	∅ mm	↓ mm	⊞
DRF110N	107	105	0,6
DRF130N	126	125	1,0
DRF150N	145	145	1,6
DRF170N	168	170	2,5
DRF200N	195	194	4,0

- S449
- 5615C
- 5415C
- 443U
- S433

A round flowerpot that, by its interesting texture, breaks the monotony in any space. Horizontal lines formed on the flowerpot make it look extraordinary.

A round flowerpot that, by its interesting texture, breaks the monotony in any space. Horizontal lines formed on the flowerpot make it look extraordinary and moulded legs are perfect for elevating plants from floor level or surface.





Sandy Round

	Ø mm	↑ mm	↓ mm
DSR130	128	111	0,9
DSR160	158	138	1,7
DSR190	189	165	3,0
DSR220	225	192	5,0
DSR260	262	222	7,9

- S449
- CY728
- 7529U
- 405U
- S433

Sandy P

	Ø mm	↑ mm	↓ mm
DSY110P	108	102	0,6
DSY130P	129	120	1,0
DSY150P	149	139	1,6
DSY170P	168	157	2,3
DSY190P	188	175	3,3
DSY240P	239	225	6,9
DSY290P	282	260	11,3

- S449
- CY728
- 7529U
- S433



Openwork Sandy Round flowerpot that interestingly displays its structure. Equipped with an insert protecting against the soil pouring out. The collection in delicate neutral and pastel colours will adorn any space.

A flowerpot from the Sandy P collection with a surface enriched with gently undulating vertical grooves, resembling the look of desert sand. Equipped with a tray with a self-locking system.





JOIN THE NATURE
regular collection



regular



Sandy Bowl

	∅ mm	↑ mm	↓ L
DSK180	180	136	1,4
DSK240	238	161	2,3
DSK290	290	195	3,9
DSK370	370	218	9,0

- S449
- 405U
- S433

The extremely decorative, hanging Sandy flowerpot will be a strong accent when creating a cosy interior. Inspired by hand-moulded, traditional ceramics.



Metal Hanger

	← mm	↘ mm	↑ mm
IWS	90	130	7





Splofy Bowl

	□	∅ mm	↑ mm	📄
DKSP180		180	136	1,4
DKSP240		239	161	2,3
DKSP290		290	195	3,9
DKSP370		370	218	9,0

S449 7529U S433

A flowerpot from the Splofy collection in the shape of a slightly flattened sphere and with a texture faithfully resembling loosely woven, soft, thick yarn. Clear, spatial, openwork braids. Comes with a specially designed insert.



Metal Hanger

	□	← mm	↘ mm	↑ mm
IWS		90	130	7





JOIN THE NATURE
regular collection

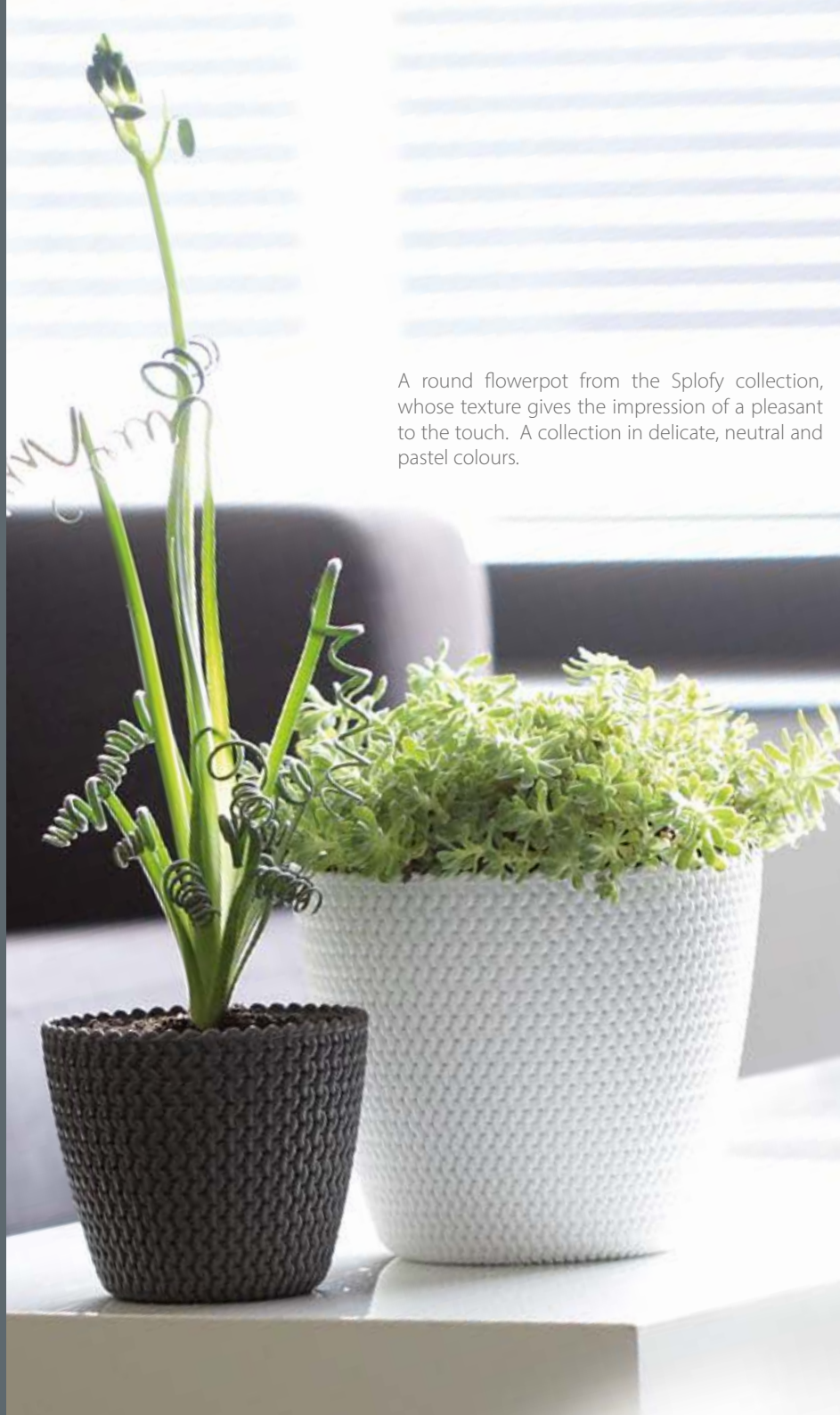

A round flowerpot from the Splofy collection, whose texture gives the impression of a pleasant to the touch. A collection in delicate, neutral and pastel colours.



Splofy Round W

	mm	mm	mm
DSPW230	230	145	3,0
DSPW270	270	166	4,8

S449 S433



Splofy Case

	mm	mm	mm	mm
DSPC300	297	157	133	4,0
DSPC400	397	180	145	7,4

S449 405U S433



Splofy

	mm	mm	mm
DSP130	130	108	0,9
DSP160	157	132	1,7
DSP190	187	158	3,0
DSP220	218	184	5,0
DSP260	259	220	8,0
DSP300	295	249	11,5

S449 S433 405U 7529U

DSP350	341	289	18,6
DSP400	391	330	28,2

S449 S433



Splofy Low

	mm	mm	mm
DSPM240	236	123	3,8

S449 S433





regular



Orient



	mm	mm	mm
DOR130	128	112	1,0
DOR160	157	138	2,0
DOR190	189	167	3,5
DOR220	218	193	5,4
DOR250	258	229	9,0

S449 405U



Wheaty



	mm	mm	mm
DWH130	128	112	1,0
DWH160	157	138	2,0
DWH190	189	167	3,5
DWH220	218	193	5,4
DWH260	258	229	9,0

S449 S433

A round flowerpot with a textured surface, reminiscent of hand-made woven products made from dried grasses.

The ornament on the surface of the flowerpot refers to the style of Far East design. An element that complements interior design and introduces an oriental character to any space.





JOIN THE NATURE
regular collection



Discover

Rattan texture



Rato Round

	mm	mm	mm
DRTUS200L	200	190	4,0/4,75
DRTUS250L	250	224	7,5/8,70
DRTUS300L	300	270	15,0/15,3
DRTUS400L	400	375	35,0/37,65

S449 7529U 440U
 S433

Metal Hanger

	mm	mm	mm
IWS	90	130	7



rosperplast®
regular

Rato Round W

	mm	mm	mm
DRTW260	256	219	6,5/8,9

440U S433



Rato Tubus

	mm	mm	mm
DRTUS200	200	381	4,0/8,0
DRTUS250	250	476	9,0/15,5
DRTUS300	300	572	15,0/27,0
DRTUS400	400	763	35,0/64,0

S449 7529U 440U
 S433

A simple, round flowerpot with a texture rattan braid. Inscribed with the emblem of the Rato collection. Included with a specially designed insert.

Rato tubus - tall, slim flowerpot from the Rato line, with texture closely resembling natural rattan weave. Functional, of a warm exotic character, the product creates a great addition to stylish interiors.





JOIN THE NATURE
regular collection



Tall Rato Square flowerpot with texture closely resembling natural rattan weave, in a classical, pure form, enables you to freely create unique interiors and spaces around the home.

A square flowerpot from the Rato line, with a texture closely resembling natural rattan weave. Thanks to its classical, pure form, it enables you to freely create unique interiors and spaces around the home, combining different styles and tastes.



Rato Low

	mm	mm	mm	mm
DRTS170L	170	170	170	3/4,0
DRTS200L	200	200	202	5/6,8
DRTS225L	223	223	228	8/9,8
DRTS265L	262	262	266	11/15,8
DRTS325L	320	320	325	21/32,0
DRTS400L	400	400	408	37/64,0

- S449
- 7529U
- 440U
- S433



Rato Square

	mm	mm	mm	mm
DRTS170	170	170	324	3,0/7,2
DRTS200	200	200	376	5,0/11,4
DRTS225	225	225	421	8,0/16,3
DRTS240	240	240	449	7,5/19,0
DRTS265	265	265	500	11,0/26,6
DRTS300	287	287	550	14,0/35,0
DRTS325	325	325	610	21,0/49,0
DRTS400	400	400	750	37,0/91,5

- S449
- 7529U
- 440U
- S433

regular



Rato Case

	mm	mm	mm	mm
DRTC500	514	192	186	17,0
DRTC600	600	250	240	30,0
DRTC800	800	330	320	72,0

- S449
- 7529U
- 440U
- S433



Rato Case High

	mm	mm	mm	mm
DRTC600H	600	250	460	30,0
DRTC800H	800	330	650	72,0

- S449
- 7529U
- 440U
- S433

Cases from the Rato line with texture closely resembling natural rattan weave. A great complement to a stylish interior design. The standard set includes an irrigation system.





Rato Case

	mm	mm	mm	mm
DRC400	395	185	195	8,0/12,0
DRC600	580	180	195	12,0/18,0

440U S433



Rato Case W

	mm	mm	mm	mm
DRC400W	395	185	195	8,0/12,0
DRC600W	580	180	195	12,0/18,0

440U S433



Rato Case M

	mm	mm	mm	mm
DRC800M	770	235	406	27,0/72

S449 7529U 440U
S433



Rato Case T

	mm	mm	mm	mm
DRC600T*	580	180	498	12,0/44,0
DRC800T**	770	235	686	27,0/100

S449 7529U 440U
S433

* 1 stabilizer included
** 2 stabilizers included



Cases from the Rato line with texture closely resembling natural rattan weave. A great complement to a stylish interior design. Functional, of a warm exotic character, the product creates a great addition to any space.





JOIN THE NATURE
regular collection



Ratolla Round W



	mm	mm	mm
DRLW215	217	142	3,40
DRLW240	243	160	4,85

- S449
- 7529U
- 440U
- S433

regular



Ratolla Round



	mm	mm	mm
DRL0145	145	127	1,2
DRL0165	165	142	2
DRL0190	190	165	2,8
DRL0220	220	195	4,2
DRL0250	250	219	7,5
DRL0300	300	264	11

- S449
- 7529U
- 440U
- S433



Ratolla Railing Square



	mm	mm	mm	mm
DRLB280	272	272	225	8,5
DRLB400	396	272	225	13

- 7529U
- 440U
- S433



Ratolla Railing Oval



	mm	mm	mm	mm
DRLB300	298	242	225	6,0

- 7529U
- 440U
- S433

Oval and rectangular boxes designed for installing on handrails and balustrades. Adjustable to various railing types. They decorate both sides of the railing, which makes an impression when viewed both from outdoors and indoors. Both are from the exotic ratolla collection with texture that resembles rattan braid.





Ratolla Square

	← mm	↘ mm	↑ mm	Ⓛ
--	------	------	------	---

DRLK145	145	145	126	1,5
DRLK165	165	165	142	2,5
DRLK190	190	190	159	3,8
DRLK220	220	220	189	6,0
DRLK250	250	250	220	8,2

S449 S433



Ratolla Case P

	← mm	↘ mm	↑ mm	Ⓛ
--	------	------	------	---

DRL300P	293	119	126	3,0
DRL400P	386	154	142	6,0
DRL500P	492	172	174	12,0
DRL600P	590	154	142	8,5

S449 7529U 440U
S433



Ratolla Case PW

	← mm	↘ mm	↑ mm	Ⓛ
--	------	------	------	---

DRL400PW	386	154	142	6,0
DRL500PW	492	172	174	12,0
DRL600PW	590	154	142	8,5

S449 7529U 440U
S433



Ratolla Case P

	← mm	↘ mm	↑ mm	Ⓛ
--	------	------	------	---

ISR400P	391	173	150	6,3
ISR500P	489	173	150	8,1
ISR600P	587	173	150	9,9
ISR700P*	685	173	150	11,7
ISR800P*	783	173	150	13,5

7529U 440U S433



Rectangular flowerpots from the Ratolla collection with a texture faithfully resembling rattan braid. Ratolla Case P is equipped with a tray with a self-locking system. The longest one is 80 cm long !





JOIN THE NATURE
regular collection

Plant box with special insert for an ideal plant irrigation. The insert design extend time of moisture in the earth and reduces its evaporation. Set includes attaching hooks for self fixing.



Boardee Fencycase

	← mm	↘ mm	↓ mm	📄
DDEF400	380	180	162	6,0
DDEF600	580	180	162	9,7

S449 R222 405U

S433



regular

Boardee Fencycase W

	← mm	↘ mm	↓ mm	📄
DDEF400W	380	180	162	6,0
DDEF600W	580	180	162	9,7

S449 R222 405U

S433



Boardee Case

	← mm	↘ mm	↓ mm	📄
DDEC400	383	144	130	4,9
DDEC600	587	144	130	7,9

S449 R222 S433

Compact version of a trendy Boardee case, equipped not only with self watering system but also with comfortable metal hangers.

A box that perfectly suits both with rural as well as minimalist, idyllic interiors. A palette of earth colours facilitates the creation of unique arrangements.





resembling
made
of boards



Boardee Hook

	mm	mm	mm	
DDECZ400	383	212	130	4,9

- S449
- R222
- 405U
- S433



Boardee Hook

	mm	mm	mm	
DDEZ150	144	212	130	1,4
DDEZ200	194	212	130	2,2

- S449
- S433



Boardee Basic

	mm	mm	
DDE150	144	130	1,4
DDE170	165	150	2,2
DDE200	199	179	3,9
DDE240	239	215	7,0
DDE290	285	256	12,0

- S449
- S433



Boardee Wall

	mm	mm	mm	
DDES200	194	150	202	2,2
DDES280	274	150	202	3,3

- S449
- S433

A flowerpot from the Boardee collection is designed for attaching to walls, but you can also place it on the kitchen counter or on the terrace floor, thus making great use of the available space.





JOIN THE NATURE
regular collection

big size
includes wheels

A tall, round flowerpot with a characteristic, wide edge. Displayed in spacious interiors, on terraces or in gardens, it warms up harsh rooms, transforms routes, passages or squares with its sophisticated aesthetics. Specially designed trays.



Lofly

	☐	∅	↑	ⓘ
	mm	mm	mm	
DLOF135	134	120	1,0	
DLOF160	158	144	1,75	
DLOF200	196	181	3,4	
DLOF250	245	225	6,7	
DLOF300	293	266	11,5	
DLOF350	345	311	18,8	
DLOF400	390	352	27,3	
DLOF500	476	425	52,0	
DLOF600*	582	523	54,7	

- S449
- 405U
- S433

*Lofly DLOF 600 includes wheels

regular



Lofly Saucer

	☐	∅	↑
	mm	mm	mm
PPLF105	105	17	
PPLF125	125	20	
PPLF155*	155	25	
PPLF190*	190	31	
PPLF230*	230	37	
PPLF270*	270	44	
PPLF305	305	49	
PPLF380	380	62	

- S449
- 405U
- S433



Lofly Railing

	☐	←	↗	↑	ⓘ
	mm	mm	mm	mm	
DLOFR250	245	245	225	5	
DLOFR400	396	266	250	12,3	

- S449
- 405U
- S433
- R624
- 389U
- 235C





Lofly Case

	← mm	↘ mm	↑ mm	ⓘ
DLOFC400	378	177	164	8,0
DLOFC600	578	257	244	26,0
DLOFC800	792	352	334	71,5
DLOFC1000*	992	390	410	111,5

*Lofly case in 1000 size includes stability metal spacers across

*Big size includes wheels

405U S433



Lofly Saucer Case

	← mm	↘ mm	↓ mm	ⓘ
PPLFC360	360	148	24	
PPLFC535	535	212	34	
PPLFC735	732	290	49	
PPLFC920*	920	315	59	

*Big size includes wheels

405U S433



Lofly Low

	← mm	↘ mm	↑ mm	ⓘ
DLOFL200	193	193	181	4,5
DLOFL240	234	234	220	8,0
DLOFL300	289	289	271	15,2

S433



Lofly Square

	← mm	↘ mm	↓ mm	ⓘ
DLOFQ200	193	193	293	7,2
DLOFQ240	234	234	356	12,9
DLOFQ300	289	289	439	24,3

S433

Lofly Saucer Square

	← mm	↘ mm	↓ mm	ⓘ
PPLFQ165	165	165	27	
PPLFQ200	200	200	32	
PPLFQ245	245	245	40	

S433

A solid, rectangular box from the Lofly collection. It looks great both in spacious interiors and on terraces or in gardens. The largest one in the series has integrated wheels so as to be moved more easily.

JOIN THE NATURE

A modern system of vertical gardens brings an extremely attractive aspect of nature into the interior and the surroundings, creating contact with nature without leaving your home and improving indoor air quality. Modular systems attached to the walls in various configurations create spectacular green displays. Available in a hanging version and a portable version with a drainer. Thanks to the flow-through irrigation system, the plants are evenly supplied with water. Its excess is discharged to a saucer or drainer. The set does not include the water distribution system.







JOIN THE NATURE
regular collection



regular



Cascade Garden Wall

	mm	mm	mm	mm	mm
I02W600W	670	177	570	12x0,75	
S433					



A modern system of vertical gardens brings an extremely attractive aspect of nature into the interior and the surroundings, creating contact with nature without leaving your home and improving indoor air quality. Modular systems attached to the walls in various configurations create spectacular green displays. Thanks to the flow-through irrigation system, the plants are evenly supplied with water. Its excess is discharged to the saucer.

modular & portable flowerpot system



Prosperplast®
regular



Cascade Garden

	mm	mm	mm	
I02W600S	685	190	546	12x0,75

S433



A modern system of vertical gardens brings an extremely attractive aspect of nature into the interior and the surroundings, creating contact with nature without leaving your home and a suitable indoor microclimate. Modular systems attached to the walls in various configurations create spectacular green displays. Thanks to the flow-through irrigation system, the plants are evenly supplied with water. Its excess is discharged to the drainer. The set does not include the water distribution system.



JOIN THE NATURE
regular collection



extremely
attractive aspect
of nature



regular

Cascade Garden Wall

	mm	mm	mm	
103W800	780	190	350	-
S433				

Create your own unique composition and add more modules!

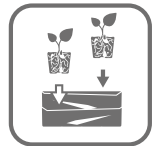
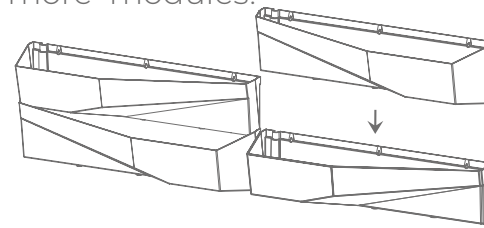

A modern system of vertical gardens brings an extremely attractive aspect of nature into the interior and the surroundings, creating contact with nature without leaving your home and improving indoor air quality. Thanks to the flow-through irrigation system, the plants are evenly supplied with water. Its excess is discharged to the saucer.



Prosperplast®
regular



Mini Cascade

	mm	mm	mm	
I01W200	195	114	475	4x1,0

S449

S433

Cascade pot which can be mounted on the wall.

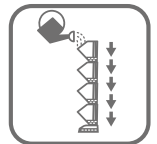

Package includes 1 set.
For double option 2 sets needed.



extremely
attractive aspect
of nature

JOIN THE NATURE
regular collection



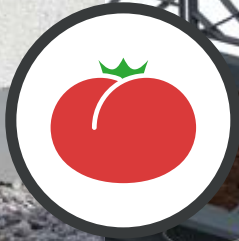
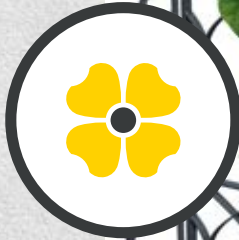

new

quick and easy
installation

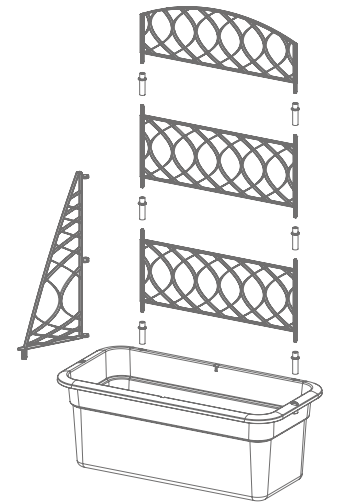

new

Bloma

	mm	mm	mm	total mm
DBL0600	580	288	225	780
405U	S433			



bloma

Bloma is a set consisting of a long and spacious flowerpot in the form of a rounded box with a detachable pergola. The pergola is made up of five parts and connectors, creating a decorative support for climbing plants. Additionally, the set includes a brace for the planter, strengthening the structure. Bloma will work perfectly on the terrace, spacious balcony, or gazebo as a green separating wall. The planter is suitable for growing ornamental plants and vegetables such as peas, tomatoes, or cucumbers.





JOIN THE NATURE
regular collection



minimalist style

regular



Respana Basic

	∅ mm	↑ mm	↓ l
DRE300	295	221	7,5
DRE390	390	273	16,0

S433



Respana Twins

	← mm	↗ mm	↓ mm	↓ l
DRED200	463	200	336	2 x 2,5

S433



Respana W

	∅ mm	↑ mm	↓ l
DREW210	208	125	2,0
DREW240	234	135	3,0
DREW270	270	145	4,0

S433



Respana Trio

	∅ mm	↑ mm	↓ l
DRET123S	470	405	28,1

S433

A box for mounting on balcony railing. It is distinguished by its sophisticated shape and simple use. Plants with hanging, flowered shoots look best in it.





An elongated box with an ergonomic shape. The elegant form of the flowerpot will decorate any interior as well as a terrace or balcony. Equipped with a tray with a self-locking system.

A traditional rectangular flowerpot equipped with a tray with a self-locking system. The classic shape fits perfectly into any interior and provides many options for arranging the space on the terrace or balcony.



Respana Set

	← mm	↗ mm	↑ mm
ISE400P	392	184	150
ISE500P	490	184	150
ISE600P	590	184	150
ISE800P	786	184	150
ISE900P	885	184	150

- S449
- R222
- 405U
- S433
- R624



Respana Easycare W

	← mm	↗ mm	↑ mm
ISE400SW	397	190	140
ISE600SW	593	190	140

- 405U
- S433
- R624
- R222



Respana Easycare

	← mm	↗ mm	↑ mm
ISE400S	397	190	140
ISE600S	593	190	140

- 405U
- S433
- R624
- R222



Respana Railing

	← mm	↗ mm	↑ mm	⊥
DREB290	288	298	209	9,0
DREB400	398	298	209	13,0

- S433





JOIN THE NATURE
regular collection







Discover

Urbi collection









Urbi Round

				
	mm	mm	mm	
DURO250	250	250	7,5 / 9,0	
DURO300	300	295	15,0/17,0	
	S449	7529U	S433	







Urbi Square Low

					
	mm	mm	mm	mm	
DURS240L	240	240	235	7,5/10,0	
DURS300L	295	295	290	14,0 / 19,0	
	S449	7529U	S433		



Urbi Square

					
	mm	mm	mm	mm	
DURS125*	126	126	200	- / 2,0	
DURS140	140	140	265	2,0/4,0	
DURS170	170	170	325	3,0/7,2	
DURS200	195	195	375	5,0/11,4	
DURS225	220	220	420	8,0/16,3	
DURS240	240	240	449	7,5/19,0	
DURS265	265	265	500	11,0/26,6	
DURS300	295	295	550	14,0/35,0	
DURS325	325	325	610	21,0/49,0	
DURS400	400	400	750	37,0/91,5	
	S449	S433			

A flowerpot with a square base from the Urbi collection. A delicately rounded shape and matt finish create an elegant and simple planter. It includes a liner which reduces the amount of soil needed.





JOIN THE NATURE
regular collection



Urbi Case

	mm	mm	mm	mm
DUC400	395	185	195	8,0/12,0
DUC600	580	180	195	12,0/18,0
DUC800	770	235	246	27,0/40,0

S449 7529U S433



Urbi Case M

	mm	mm	mm	mm
DUC800M	770	235	406	27,0/72,0

S449 7529U S433



Urbi Case N

	mm	mm	mm	mm
DUC800N	770	235	300	27,0/40,0

S449 7529U S433



regular

Urbi Case W

	mm	mm	mm	mm
DUC400W	395	185	195	8,0/12,0
DUC600W	580	180	195	12,0/18,0

S449 7529U S433



Urbi Case T

	mm	mm	mm	mm
DUC600T*	580	180	498	12,0/44,0
DUC800T**	770	235	686	27,0/100

S449 7529U S433

* 1 stabilizer included
** 2 stabilizers included





Elevated by wooden looking legs Urbi Case N will add a contemporary and timeless styling to floor standing flower arrangements, indoor and outdoor. Equipped with an insert protecting against soil pouring out.





JOIN THE NATURE
regular collection



Tubus Slim



	mm	mm	
DTUS150	150	286	2,0/3,3
DTUS200	200	381	4,0/8,0
DTUS250	250	476	7,5/15,5
DTUS300	300	572	15,0/27,0
DTUS400	400	762	35,0/64,0

S449



regular

Tubus Slim Shine



	mm	mm	
DTUS150S	150	286	2,0/3,3
DTUS200S	200	381	4,0/8,0
DTUS250S	250	476	7,5/15,5
DTUS300S	300	572	15,0/27,0
DTUS400S	400	762	35,0/64,0

S449



Tubus



	mm	mm	
DTUB200	200	187	3,5
DTUB250	250	233	7,0
DTUB300	300	280	12,0
DTUB400	400	373	28,5

S449

S433

An elegant, high flowerpot may function as a decoration in both a stylish loft and a small terrace. Perfect for residential and urban spaces. It includes an insert which reduces the amount of soil needed. An irrigation system is an optional solution.





Lace

	∅ mm	↑ mm
DLAC 115	112	130
DLAC 140	135	155
DLAC 160	160	185
DLAC 180	180	210

S449



Lace

	← mm	↗ mm	↑ mm
DLAC285	285	135	155

S449

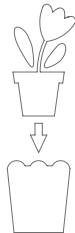

A series of round, oblong Lace flowerpots was created with an intricate openwork lace motif, in response to the trend promoting traditional folk design. Intentional simplicity of nostalgia for years gone by...



regular



Coubi Orchid

	← mm	↗ mm	↑ mm	ⓘ
DUMS200P*	198	130	102	1,0
DUMS360P*	360	150	132	3,8

*polystyrene

CPNO



Coubi Orchid

	← mm	↗ mm	↑ mm	ⓘ
DUMS200	198	130	102	1,0
DUMS360	360	150	132	3,8

S449

S433



The exquisite, elliptical shape and functionality of the Coubi flowerpot is aesthetically glamorous. The transparent surface allows you to admire the plant growing in all its glory.





JOIN THE NATURE
regular collection



regular

help
for
growing

Orchid Lovers will fully appreciate these unique design sticks, both practical and stylish. There are dedicated for miniature orchids and other small flowering plants.

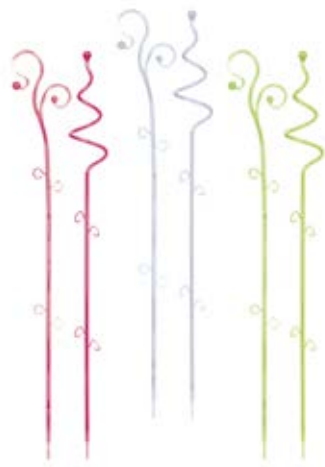

Decor Orchid Sticks

	mm	mm	pcs
ISTC01*	90/60	585	12

*polycarbonate
*mix design 24 + 24 pcs



Decor Orchid Sticks

	mm	mm	pcs
ISTC02*	40	550	20

*polycarbonate



Decor Orchid Sticks

	mm	mm	pcs
ISTC03*	50	390	20

*polycarbonate



decor



flexible



Coubi Orchid



DUK0130P* 132 132 165 1,6

*polystyrene



Coubi Orchid



DUS130P* 130 170 1,3

*polystyrene



Coubi Orchid



DUOW130P* 130 160 1,5

DUOW160P* 160 183 2,4



Coubi Orchid



DUOW130T 130 160 1,5

DUOW160T 160 183 2,4



Coubi Orchid



DST0125 125 147 1,1



Coubi Orchid



DST0125M 125 147 1,1



The classic shape and minimalistic form of Coubi creates a modern effect, constituting a wonderful setting for the orchid, which, however, does not overshadow the natural beauty of this flower. Models with a transparent and matt surface are available.

Flowerpots from the Coubi series with a harmonious shape and a variety of surfaces. The transparent and matte model are perfect for orchids.





JOIN THE NATURE
regular collection



regular



Coubi Round P

	∅ mm	↑ mm	↓ mm
DUOP100	100	92	0,5
DUOP120	120	110	0,8
DUOP135	135	124	1,2
DUOP155	155	142	2,0
DUOP180	180	165	2,8
DUOP210	210	193	4,2
DUOP240	240	220	7,5
DUOP280	280	262	11,0

S449

426U



Coubi Square P

	← mm	↘ mm	↑ mm	↓ mm
DUKP100	100	100	92	0,5
DUKP120	120	120	110	1,2
DUKP135	135	135	124	1,5
DUKP155	155	155	142	2,5
DUKP180	180	180	165	3,8
DUKP210	210	210	192	6,0
DUKP240	240	240	220	8,2

S449

426U



Coubi Case P

	← mm	↘ mm	↑ mm	↓ mm
DUPP240	240	120	110	2,5
DUPP300	290	142	136	4,4
DUPP400	390	190	182	10,6

S449

426U

A round flowerpot with a shiny surface and classic shape, equipped with a tray with a self-locking system. Available in a wide range of the most fashionable, cheerful colours.

The glossy surface of flowerpots from the Coubil series will brighten and add a distinctive character to any interior. Equipped with a tray with a self-locking system.





Coubi Herbal

	mm	mm	mm	
DKN3003	295	295	380	9,0
S449	426U			



Coubi Chain

	mm	mm	mm
IL300W	100	10	130
Accessory for flowerpot DKN3003.			



Herbs cut

	mm	mm	mm
ICUT1	130	60	12
S449	389U		

Herbs Cut scissors are a must-have accessory for any plant grower. The unique triple blade ensures the ease and precision of cutting.



Limes Dublo

	mm	mm	mm	
DL0250	250	120	120	2,3
S449				



Twins Cube

	mm	mm	mm	
DTC245	244	110	120	2,5
S449				



The flowerpots are distinguished by their original, modern shape, which adds a unique character to your home herb garden. The flowerpots have a convenient opening for placing scissors. Herbs Cut scissors with a special triple blade are available as part of a set.





JOIN THE NATURE
regular collection



regular



Crown



DCRO480	480	264	16,0
---------	-----	-----	------

S433



Crown



DCRO240	242	278	201	7,0
DCRO400	393	278	201	12,0
DCRO600	580	278	201	18,0

S449

R624

S433



A patio flowerpot with an original shape and a wide range of applications. The pots have special recesses, allowing them to be arranged one on top of the other, creating an interesting cascade effect. Easy to stack.

The series of Crown rail planter boxes is very easy to attach to the balcony thanks to the recess in its base and special brackets, which guarantee stability. Resistant to sunlight and mechanical damage. Adjustable to different railing types.





Agro balcony case of a rectangular shape and subtle pressed markings on its surface is a universal product, perfect for the cultivation of various plants: flowers, herbs or vegetables. It may be mounted on balcony railings or placed on the floor or a window sill.



Camelia

	← mm	↗ mm	↑ mm	Ⓜ
DCM400	402	170	143	5,5
DCM500	508	188	173	9,6
DCM600	595	170	143	8,5

R624 R222



Camelia W

	← mm	↗ mm	↑ mm	Ⓜ
DCM400W	402	170	143	5,5
DCM500W	508	188	173	9,6
DCM600W	595	170	143	8,5

R624 R222



A simple rail planter box with a slightly rounded edge. It can be placed on the windowsill, the kitchen counter or, by using the system of hooks, hung on the balcony or terrace railing. The box is equipped with a tray with a self-locking system and a special opening for easy watering.



Agro

	← mm	↗ mm	↑ mm
IS400	400	180	140
IS500	500	180	140
IS600	600	180	140
IS700	700	180	140
IS800	800	180	140
IS1000	1000	180	140

S449 S433
R624 R222

optional hanger



Agro

	← mm	↗ mm	↑ mm
IP400	345	127	28
IP500	445	127	28
IP600	544	127	28
IP700	653	127	28
IP800	753	127	28
IP1000	953	127	28

S449 S433
R624 R222





for hydroponic cultivation

JOIN THE NATURE
regular collection



regular



Balcony can

	mm	mm	mm	l
IS6CAN	600	180	140	11,0

R624



Balcony can

	mm	mm	mm	l
ISBT5CAN	500	190	160	7,5

R624

Classic, rectangular rail planter boxes which can be placed on the windowsill or patio, and the agrohanging hooks make it possible to install them on a fence or balcony railing. Included with an irrigation system for hydroponic cultivation, allowing the accumulation of water at the bottom of the pot, which reduces the frequency of watering.



Hangplast

	mm	mm
IWWS	200/250	190

S449

S433

R624

R222



Agrohang



	mm	mm
IWAG	230	210

S411







Agro

	 mm	 mm	 mm
DAGW1	160	100	0,8
DAGW2	180	115	1,2
DAGW3	210	130	2,0
DAGW4	240	150	3,0
DAGW5	270	160	4,5

R624



Plastica

	 mm	 mm	 mm
DP15	150	112	0,9
DP17	170	127	1,4
DP20	200	150	2,5
DP23	230	174	3,5
DP28	280	212	6,5
DP34	340	257	12,0
DP40	400	303	21,0

R624





Akant

	 mm	 mm
IWA	200	230



Plastica

	 mm	 mm
PP15	151	27
PP17	168	30
PP20	195	34
PP23	222	39
PP28	263	44
PP34	311	47
PP40	359	50

R624

Agro resembles traditional terracotta pots. Both in a set with a tray and a hook, which can be easily dismantled and turned into regular standing flowerpots.





JOIN THE NATURE
regular collection



regular



Misa

	mm	mm	mm
DMS01	130	70	0,5
DMS02	150	77	0,6
DMS03	170	85	0,9

R624

	mm	mm	mm
DMS04	200	94	1,25
DMS05	225	102	2,0
DMS06	260	113	3,0
DMS07	300	124	4,0
DMS08	340	136	5,5

R624



Glinka

	mm	mm	mm
DGA11	110	90	0,25
DGA13	130	110	0,75
DGA15	150	126	1,1
DGA17	170	142	1,6
DGA19	190	160	2,25
DGA22	220	190	3,9
DGA26	260	225	5,9
DGA30	300	260	9,4

R624



Glinka

	mm	mm
PG10	95	24
PG11	110	27
PG13	130	32
PG15	145	35
PG17	160	40
PG19	190	45
PG22	220	50
PG26	255	60

R624

The Misa flowerpot resembles ceramic pots, a delicate ornament and a subtly textured surface adds to its elegance and grace.

The simple, timeless design makes it a perfect match for any garden or interior. The flowerpots are a perfect imitation of traditional clay products, but unlike them, they do not break easily. They create a perfect set.

A classic flowerpot shape with a delicately curled edge will work in any home décor, additionally decorated with a delicate ornament.





Terra plant pot from our trusted Terra Family line is an ideal choice for lovers of simple and classic designs. The product is universal and very durable.



Terra

	∅ mm	↑ mm	↓ mm
DCE11	110	85	0,5
DCE13	130	100	0,7
DCE15	150	115	1,0
DCE17	175	135	2,0
R624			
DCE20	200	155	3,0
DCE25	250	195	5,0
DCE30	300	235	8,0
DCE35	350	275	13,0
DCE40	400	315	20,0
DCE45	450	350	27,0
DCE50	500	390	38,0
DCE55	550	430	48,0
DCE64	640	500	78,0
R624 S433			



Terra

	∅ mm	↑ mm	↓ mm
DMT20	200	95	2,0
DMT25	250	115	3,6
DMT30	300	130	6,0
DMT35	350	150	9,8
DMT40	400	170	14,5
R624			



Terra

	∅ mm	↑ mm
POD09	90	12
POD11	110	14
POD12	120	16
POD14	140	19
R624		
POD17	170	22
POD21	210	27
POD25	250	33
POD29	290	38
POD33	330	44
POD37	370	49
POD41	410	55
POD46	460	60
POD54	540	69
R624 S433		

A wide bowl and an oval box from the Terra family. Their shape and subtle grooves, which characterise all the products from this line, beautifully complement the interior of the house or garden, regardless of their style.



A practical RONDO, round shape of the stand is equipped with a system of 4 independent, stable rollers, rotating by 360 degrees. Thanks to the unique design, we can easily move even very heavy pots in any desirable place. A high edge will keep safely water excess from spilling.



Rondo

	∅ mm	↑ mm
PCRT	305	90
R624		





JOIN THE NATURE
regular collection



regular



Terra



	mm	mm	mm	
DCK1	265	124	100	2,0
DCK2	316	132	110	2,5

R624



Terra



	mm	mm	mm	mm
DTT600	600	257	238	18,0
DTT700	700	300	277	30,0
DTT800	800	344	320	44,0

R624

S433



Terra



	mm	mm	mm
DWT23	230	140	4,0
DWT26	260	160	6,0
DWT29	290	180	8,5

R624



Terra



	mm	mm	mm	
DKWT15	150	150	130	1,7
DKWT19	190	190	160	3,5
DKWT24	240	240	200	7,0
DKWT30	300	300	250	13,8
DKWT37	370	370	300	25,2
DKWT45	450	450	350	42,0

R624

S433



Terra



	mm	mm	mm
PKWT14	140	140	19
PKWT17	170	170	24
PKWT22	220	220	30
PKWT27	270	270	38
PKWT34	340	340	45
PKWT41	410	410	55

R624

S433

Traditional, shapely flowerpots, perfectly presented in the interior of the house, balcony or patio. A subtle decorative element characteristic to the Terra family adds elegance.

Pots from the Terra family adapted for attaching to the ceiling, on flat surfaces and on poles or gutters, etc. All decorated with subtle grooves, characteristic for the Terra collection.





Shallow bowl design
in a classic finish.



Maze Cap

	mm	mm	
IPDM600	595	192	-
R736	S443	S433	

Maze Cap can be used as a rainwater tank insert or a flowerpot, perfect for seedling plants.





massive
collection



JOIN THE NATURE



Milly



	mm	mm	mm
DBMIG240	239	305	4,5/8,5
DBMIG300	298	365	10,0/18,0
DBMIG400	390	495	20,0/41,0

- S449
- 7598U
- 443U
- S433
- 4985U
- 2411U
- 446U

A trendy flowerpot with a modern cylindrical shape narrowed at the base. Its elegant proportions make it a perfect match for many interiors, especially those decorated in boho style. Equipped with an insert, it does not require full filling with soil. Thanks to the handles, you can easily remove the insert and gain access to the inside of the flowerpot.

Discover

Milly collection





JOIN THE NATURE

massive collection





Milly

	mm	mm	mm
DBMIN300	298	285	10,0/17,0
DBMIN400	295	375	20,0/38,0

S449	7598U	443U
S433	4985U	2411U
446U		



Milly

	mm	mm	mm
DBMLR300	299	270	10,0/14,0
DBMLR400	395	350	20,0/33,0

S449	7598U	443U
S433	4985U	2411U
446U		



Milly

	mm	mm	mm
DBMIR300	299	285	10,0/14,0
DBMIR400	390	370	20,0/33,0

S449	7598U	443U
S433	4985U	2411U
446U		



Discover

Milly collection

An elegant flowerpot with a cylindrical shape and a ribbed surface, perfect for modern interiors, terraces and gardens. It is available in three variants and seven colours, which ensures creativity and functionality when creating original plant compositions. It includes an insert that allows you to easily remove and water the plant.





JOIN THE NATURE
massive collection





Milly

	Ø	↑	↓
	mm	mm	mm
DBML240	239	197	4,5/7,0
DBML300	298	257	10,0/14,0
S449	7598U	443U	
S433	4985U	2411U	
446U			
DBML350	349	290	15,0/22,0
DBML400	391	321	20,0/31,0
DBML470	469	385	31,0/54,0
S449	7598U	443U	
S433	446U		



Milly

	Ø	↑	↓
	mm	mm	mm
DBMI240	238	227	4,5/7,0
DBMI300	299	311	10,0/15,0
S449	7598U	443U	
S433	4985U	2411U	
446U			
DBMI350	349	355	15,0/23,0
DBMI400	390	370	20,0/29,0
DBMI470	467	442	31,0/50,0
S449	7598U	443U	
S433	446U		

UV - and frost-resistant flowerpot with an elegant texture. Includes a liner which reduces the amount of soil needed. Self - watering system is optional.





JOIN THE NATURE

massive collection





new

new



Origina

	∅ mm	↓ mm	↓ mm
DB0240	238	214	4,5
DB0300	298	246	8,5
DB0340	338	287	13,0
DB0400	390	330	20,0

- S449
- 405U
- S433
- R736



Origina

	∅ mm	↓ mm	↓ mm
DH0400	390	460	26,5

- S449
- 405U
- S433
- R736

Origina is a classic cone-shaped flowerpot with a distinctive embossed rim. Despite appearing like heavy stone, it is made from lightweight, durable, weather-resistant, and UV-resistant material. Its simple, timeless design makes it a perfect fit for both garden and interior spaces.

Discover

Origina collection





JOIN THE NATURE
massive collection



Heos



	mm	mm	mm
DLHEN300	298	190	8,0/12,0
DLHEN400	395	240	18,0/26,0
DLHEN470	468	295	31,0/45,0

S449 S433



Heos



	mm	mm	mm
DBHEN300	298	280	10,0/17,0
DBHEN400	395	370	20,0/40,0
DBHEN470	468	440	31,0/69,0

S449 S433



Heos



	mm	mm	mm
DBHER300	298	290	10,0/19,0
DBHER400	390	380	20,0/44,0
DBHER470	468	450	31,0/74,0

S449 S433

Effortless and understated elegance abounds with the Heos collection. The smooth surface of the planter will harmonise with any setting. Available in a number of sizes and colours provides a perfect mix and match opportunity to many green arrangements.





massive



Heos



DMHET440	436	299	11,0/34,0
DMHET600	582	300	18,0/56,0

S449 S433



Heos



DBHET400	395	350	8,0/32,0
----------	-----	-----	----------

S449 S433



Heos



DPHET440	439	440	11,0/51,0
----------	-----	-----	-----------

S449 S433

UV - and frost-resistant flowerpot with an elegant texture. Includes a liner which reduces the amount of soil needed. Self - watering system is optional.





JOIN THE NATURE
massive collection



Heos

	mm	mm	mm
DLHEW300	298	190	8,0/12,0
DLHEW400	390	245	18,0/28,0

S449 S433



Heos

	mm	mm	mm
DLHET350	343	197	8,0/15,0
DLHET400	390	228	18,0/i

S449 S433



Heos

	mm	mm	mm
DBHEW300	298	280	10,0/18,0
DBHEW400	390	350	20,0/36,0
DBHEW470	469	420	31,0/69,0
DBHEW570	568	470	56,0/-

S449 S433



Heos

	mm	mm	mm
DPHEW400	390	440	20,0/46,0

S449 S433



UV - and frost-resistant flowerpot with an elegant texture. Includes a liner which reduces the amount of soil needed. Self - watering system is optional.





massive



Heos



	mm	mm	
DBHEM300	298	230	8,0/10,0
DBHEM400	395	302	18,0/25,0
DBHEM470	469	360	31,0/47,0
DBHEM570	569	435	56,0/84,0

- S449
- 7598U
- 443U
- S433



Heos



	mm	mm	
DBHEK400	370	230	8,0/18,0
DBHEK440	436	270	11,0/32,0

- S449
- S433



UV - and frost-resistant flowerpot with an elegant texture. Includes a liner which reduces the amount of soil needed. Self - watering system is optional.







massive



Heos

	 mm	 mm	 cm
DBHEP270	270	319	4,5/13,0
DBHEP340	343	429	10,0/36,0

S449	7598U	443U
S433		



Discover

HEOS collection

The Heos trendy flowerpot fits perfectly into modern interiors and gardens. Its cylindrical shape and subdued colours add elegance and simplicity, and the smooth surface makes it extremely aesthetic. The flowerpot includes an insert for easy removal of the plant and access to the inside of the pot.



JOIN THE NATURE
massive collection



Furu Bowl

	□	∅ mm	↑ mm	☕
DBFUK300		378	230	8,0/25,0
DBFUK440		435	275	11,0/36,0
	S449	443U	S433	



Furu

	□	∅ mm	↑ mm	☕
DBFU300		298	280	10,0/15,0
DBFU350		349	295	15,0/23,0
DBFU400		390	320	20,0/30,0
DBFU470		470	385	31,0/53,0
DBFU570		569	445	56,0/92,0
	S449	443U	S433	

Make a statement in your space with the newest Furu in a bowl design with a playful, lined surface. Sturdy yet elegant plantpot perfect for discerning houseplants.





JOIN THE NATURE
massive collection



massive



Maze



DLMZ400	375	279	18,0/22,0
DLMZ500	475	349	40,0/48,0

S449 405U S433



Maze



DBMZ300	296	329	10,0/16,0
DBMZ400	375	419	20,0/32,0
DBMZ500	475	523	40,0/68,0

S449 405U S433



Maze



DPMZ400	375	579	20,0/43,0
---------	-----	-----	-----------

S449 405U S433



The Maze flowerpot collection with a subtle braid motif is excellent for modern interiors. Comfortable insert allows to reduce the amount of soil needed. Self - watering system is optional.





Maze



DBMZE600	585	385	423	24,0/56,0
----------	-----	-----	-----	-----------

S449 405U S433



Maze



DBMZK400	396	260	10,0/25,0
DBMZK440	436	299	15,0/36,0

S449 405U S433



The Maze flowerpot collection with a subtle braid motif is excellent for modern interiors. Comfortable insert allows to reduce the amount of soil needed. Self-watering system is optional.





JOIN THE NATURE
massive collection



Woode

	mm	mm	mm
DBW0300	299	281	8,0/12,0
DBW0350	348	325	11,0/21,0
DBW0400	393	370	18,0/29,0
DBW0490	488	457	40,0/54,0

R222 S433



massive

Sunny

	mm	mm	mm
DBSU30	300	225	8,0
DBSU35	350	267	14,0
DBSU40	400	307	22,0
DBSU46	460	353	34,0
DBSU57	570	435	60,0

R736

Decora

	mm	mm	mm
DBDE30	300	235	8,0
DBDE35	350	280	15,0
DBDE39	390	310	21,0
DBDE45	450	358	30,0
DBDE57	570	455	65,0

R736

Sunny and Decora flowerpots from the Massive collection have been inspired by the European style and ceramics fired using traditional methods. Richly decorated with floral motifs.





Frost-resistant flowerpot with a texture real wood alike. Includes a liner which reduces the amount of soil needed.







Sand

	 mm	 mm	 mm
DBSA300	295	330	8,0/13,0
DBSA350	345	385	11,0/21,0
DBSA400	388	436	18,0/37,0

- S449
- 7529U
- 405U
- S433





Sand Slim

	 mm	 mm	 mm
DPSPA300	296	520	8,0/22,0
DPSPA350	349	619	11,0/37,0
DPSPA400	390	750	18,0/45,0

- S449
- 7529U
- 405U
- S433





Sandy

	 mm	 mm	 mm
DBSP300	297	330	8,0/13,0
DBSP350	349	380	11,0/21,0
DBSP400	390	439	18,0/30,0

- S449
- 7529U
- 405U
- S433



Sandy Slim

	 mm	 mm	 mm
DPSP300	297	513	8,0/22,0
DPSP350	349	612	11,0/37,0
DPSP400	390	708	18,0/53,0

- S449
- 7529U
- 405U
- S433



This exceptionally decorative flowerpot collection is inspired by hand-made, traditional ceramics. Their noble surface has wavy vertical grooves which reminiscent a shape and pattern of desert sand.

This exceptionally decorative flowerpot collection is inspired by hand-made, traditional ceramics. Their noble surface has wavy horizontal grooves which reminiscent a shape and pattern of desert sand.





JOIN THE NATURE
massive collection



Matuba



	mm	mm	
DBMA300	298	278	12
DBMA350	348	324	19
DBMA400	388	370	26
DBMA490	478	442	52
DBMA600	600	591	105

S433

massive



Matuba



	mm	mm	
DBMT300	300	350	8,0/14,0
DBMT400	400	480	18,0/34,0

S449

S433



Matuba Slim



	mm	mm	
DPMT300	300	550	8,0/23,0
DPMT400	400	780	18,0/57,0

S449

S433

Slender flowerpots from the exotic Matuba collection, deceptively similar to vessels weaved from bamboo fibres. An irrigation system is optional.





Classic

	∅ mm	↑ mm	↓ mm
DBC25	255	240	6,0
DBC30	300	260	10,0
DBC35	350	300	16,0
DBC40	400	340	23,0
DBC46	450	390	36,0
DBC57	580	470	67,0

R736 S433



Classic Tower

	∅ mm	↑ mm	↓ mm
DPC30	300	500	8,0/20,0
DPC40	400	630	18,0/42,0
DPC48	480	790	40,0/86,0

R736 S433



Massive

	∅ mm	↑ mm
PR21	210	31
PR27	270	40
PR33	330	49
PR39	390	58
PR45	450	67
PR51	510	76

7529U R736 S433 440U
S449

Classic flowerpot from the Massive collection, thanks to its texture, appears to be made of stone, at the same time remaining light and handy. The product has improved resistance to sunlight and low temperatures, as well as to mechanical damage.





JOIN THE NATURE
massive collection



rotating 360°



Mobile Platform Round



	mm	mm
IPMR300	292	40
IPMR400	390	45



Mobile Platform Square



	mm	mm	mm
IPMS300	292	292	40
IPMS400	390	390	45



A round mobile platform with a system of 4 independent, stable rollers, which rotate by 360 degrees. Adapted for moving heavy, massive flowerpots. The design and attachment of the rollers makes them practically invisible.



Mobile Saucer Round



	mm	mm
IPRR300	292	57
IPRR370	366	60
IPRR450	446	63



Mobile Saucer Square



	mm	mm	mm
IPRS300	292	292	57
IPRS370	366	366	60
IPRS450	446	446	63



A functional, square stand with a high edge, which secure the water excess and the plant from slipping or falling when moving around. The platform is equipped with a system of 4 independent, stable rollers, rotating by 360 degrees.

high edge





3 supporting wheels
inside roller system



wheel - system
PATENT

rotating 360°



smooth movement
of the base in each direction



a round mobile saucer
with the edge





option
create your
own set

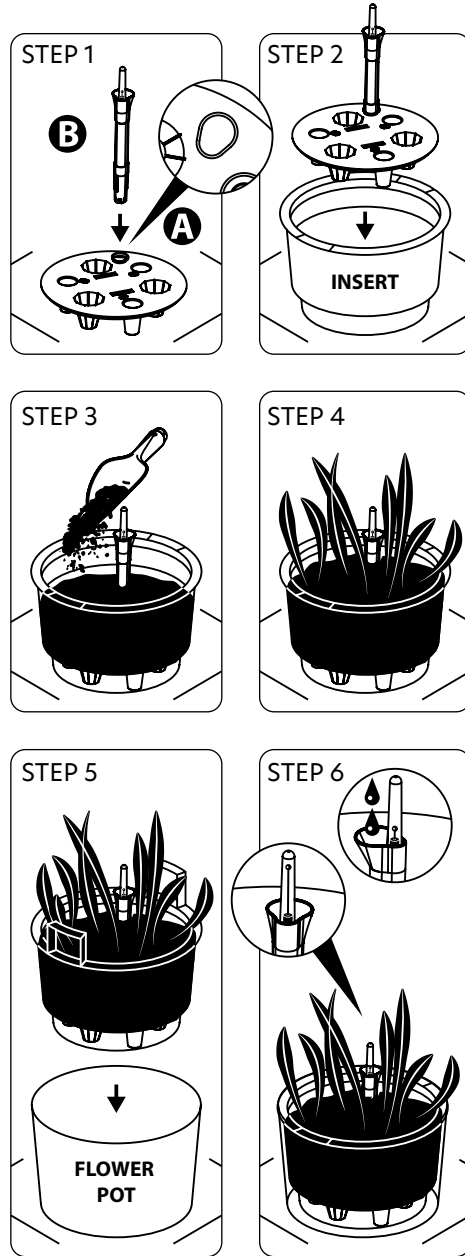

Irrigation
system
for
flowerpots

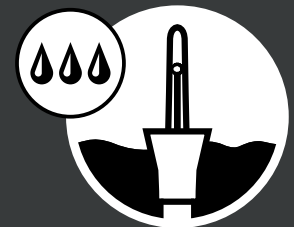
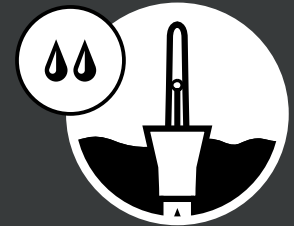
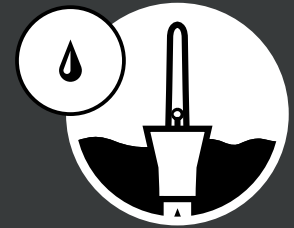

JOIN THE NATURE
regular collection

create your Watering System



A convenient way to water plants correctly. Extends the time during which the soil is wet. Allows for controlling the water level in the pot. Saves up to 50% of water by decreasing vaporisation.



Watering System Round

	← mm	↘ mm	↓ mm
WR1	170	42	170
WR2	170	42	170
WR3	212	50	212
WR4	252	59	252
WR5	277	59	277
WR6	317	57	317
WR7	340	59	340
WR8	415	62	415



Watering System Square

	← mm	↘ mm	↓ mm
WS1	210	50	210
WS2	240	50	240
WS3	245	52	245
WS4	295	55	295
WS6	360	65	360



Watering System Long

	← mm	↘ mm	↓ mm
WL1	430	219	45
WL2	505	180	42

In order to choose the right size of the irrigation system for the plantpot, look for detailed information in the Offer 2024 / 25 catalogue or ask your local sales representative.

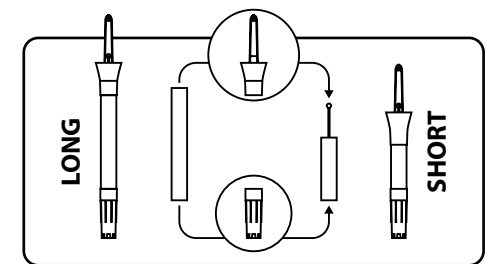

universal short and long irrigation system

Discover

Respana collection

JOIN THE NATURE



Grow your gorgeous garden
with absolute ease!





JOIN THE NATURE
regular collection



timeless elegance



Respana Planter Wood High Set

	mm	mm	mm	
ISEW780H*	770	380	795	55

*polycarbonate lid

- 405U
- S433

wooden legs



A miniature, portable greenhouse or original box with legs made of hard, light-coloured wood. Equipped with a transparent lid with adjustable ventilation openings. A combination of functionality and timeless elegance.





plant herbs to enjoy
tally fresh each day!

The portable seedbed collection from the Respana collection is an important part of the gardening backyard and a perfect solution for growers who face difficult climatic conditions. This miniature greenhouse which, does not take up much space at home, creates the perfect conditions for the growth of the seedlings through good ventilation and humidity control. Cultivation of early vegetables, herbs or warm weather-loving plants sensitive to weather conditions - can be continued regardless of weather condition outside and bringing a great joy of early harvest. The light transparent lid provides adjustable ventilation holes in order to create an ideal micro-climate and prevent from overheating plants. What is more it protects the seedlings from annoying insects.

Ecoline



Respana Planter Ecoline Set

	← mm	↘ mm	↑ mm	⊞
IPE600	596	368	753	30
IPE750	749	368	777	42

S433



Respana Planter Set

	← mm	↘ mm	↑ mm	⊞
DREP770	770	387	820	52
DREP770W	770	580	963	83

included calendar of herbs & vegetables
growing

389U

405U

S433





JOIN THE NATURE
regular collection



Grow your gorgeous garden with absolute ease!

Botanic is a portable, freestanding seedling nursery that provides optimal growth conditions for seedlings. It features a transparent cover with adjustable ventilation openings and special locking mechanisms to prevent accidental disassembly. The cover is equipped with handles for easy lifting. This compact and lightweight greenhouse creates perfect microclimatic conditions, preventing plant scorching and shielding them from insects. An additional advantage is the ability to stack one product in another (stacking). Keep in mind that the greenhouse is not completely airtight, so it is not recommended to place it on a floor that may be exposed to moisture.

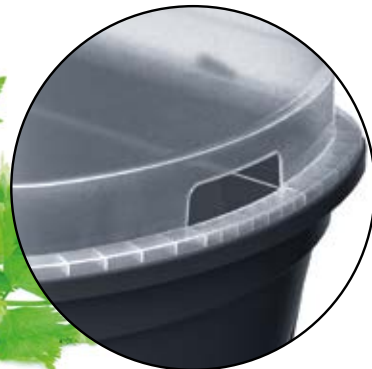

new

Botanic

	mm	mm	mm		
DBOP780	775	378	866	-	

405U S433

stackable



new

Bloomo

	mm	mm	mm		
DBLP780	775	378	820	-	

405U S433



stackable

Bloomo is a portable, freestanding seedling nursery that provides ideal conditions for seedling growth. It features a detachable, transparent cover with adjustable ventilation openings and special safeguards to prevent accidental disassembly. There are openings in the cover to facilitate its transport. The nursery can be folded as it has removable legs.





JOIN THE NATURE
regular collection

Grow fresh herbs and vegetables right in your kitchen



The kit 3in1 includes flat tray, deep tray with water drainage holes to make sure your plants get just enough water and a lid with ventilation to maximize germination.



Respana Table Greenhouse

	mm	mm	mm	
DREM260	257	196	185	1,6
DREM260P*	257	196	185	1,6

S433



Respana Table Greenhouse

	mm	mm	mm	
DREH400	391	257	185	3,6
DREH400P*	391	257	185	3,6

S433



Respana Table Greenhouse

	mm	mm	mm	
DREL400	515	196	185	3,6
DREL400P*	515	196	185	3,6

S433

Table Top Fresh Garden
Small footprint & easy to use!
Grow your favorite herbs, vegetables in pots
or straight in the tray.

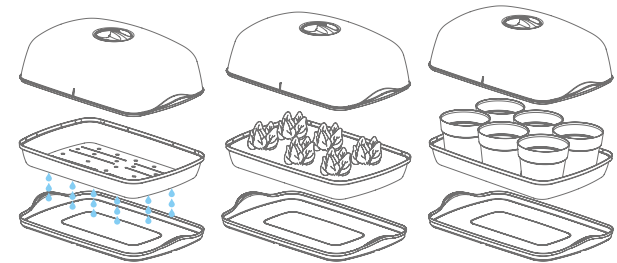



Respana Starter Set

	mm	mm	mm	
INST01	576	460	190	-
S433				



Respana Grow Tray

	mm	mm	mm	
INTC60	576	456	110	-
S433				

Create your own set

Respana Grow Tray + Respana Table Greenhouse

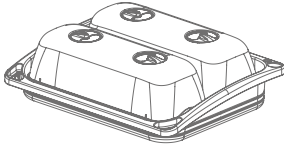

INTC60 + 2 x DREL400P

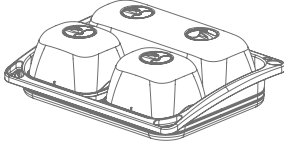

INTC60 + 1 x DREL400P + 2 x DREM260P

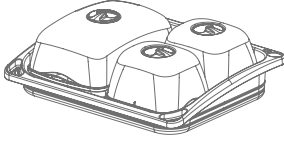

INTC60 + 1 x DREH400P + 2 x DREM260P



Grow Tray



Table Greenhouse



Hole Digger



Soil Cup



Fork



Scoop



Product images for illustrative purposes only, may differ from the actual product.



**Full comfort of use
Depending on the season!**



JOIN THE NATURE
regular collection

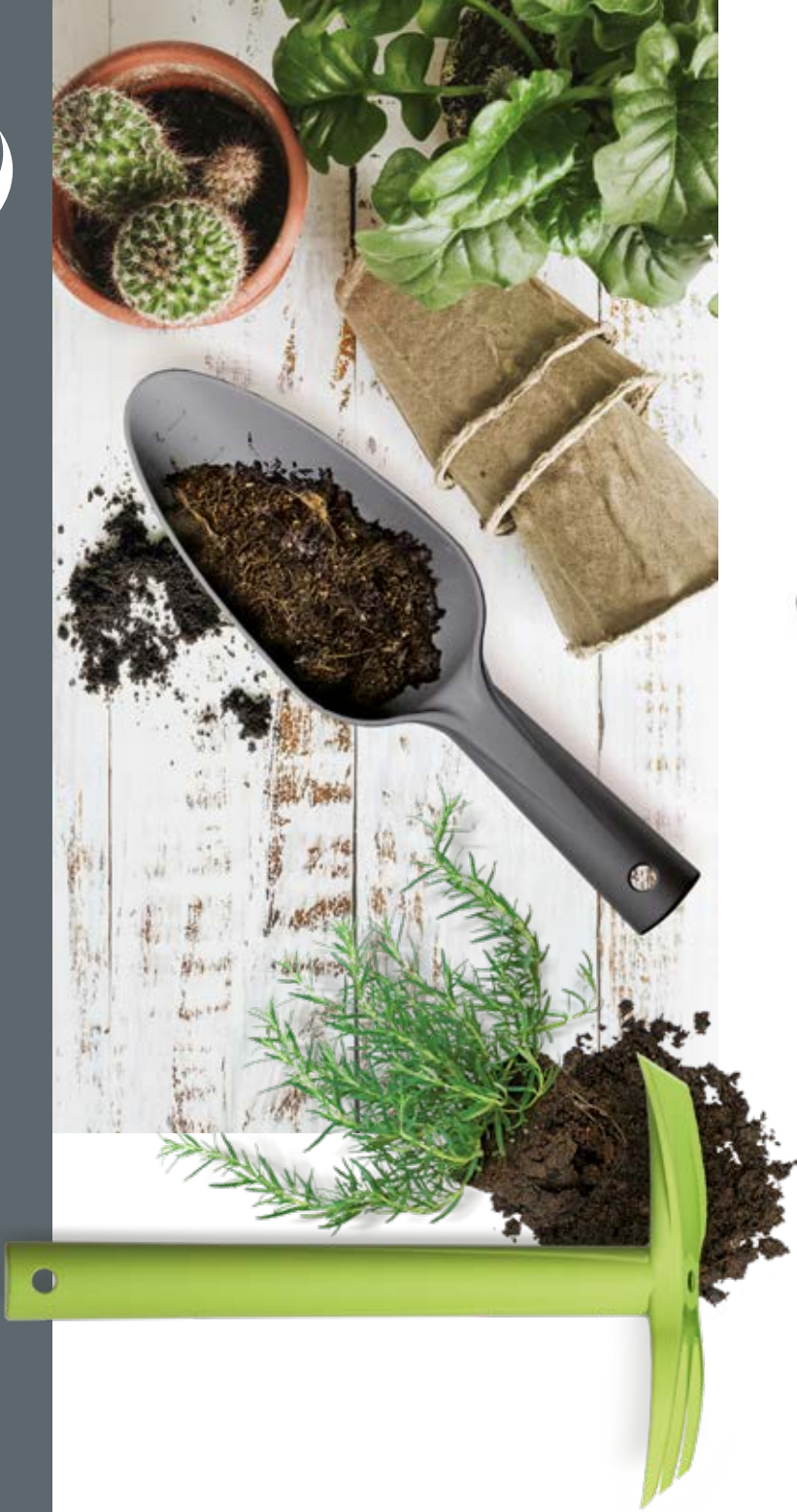

regular



R Cup

		mm	mm	mm
INNA		122	105	226

S411



R Scoop1

		mm	mm	mm
INLM		288	53	34

S411



R Scoop2

		mm	mm	mm
INLD		288	85	46

S411



R Digger

		mm	mm	mm
INPI		152	34	207

S411



R Fork

		mm	mm	mm
INGR		254	79	105

S411



R Hoe

		mm	mm	mm
INMO		290	80	196

S411



R Fork Seeder

		mm	mm	mm
INSE		255	86	58

S411



R Cultivator

		mm	mm	mm
INWD		251	78	54

S411



R Rakes

		mm	mm	mm
INGRL		520	172	63

S411





**Full comfort of use
Depending on the season!**

made of **ABS**



R Cup Plus

	mm	mm	mm
INNAAB	122	105	226

4C



R Scoop1 Plus

	mm	mm	mm
INLMAB	307	53	34

4C



R Scoop2 Plus

	mm	mm	mm
INLDAB	307	85	46

4C



R Digger Plus

	mm	mm	mm
INPIAB	171	34	207

4C



R Fork Plus

	mm	mm	mm
INGRAB	273	79	105

4C



R Hoe Plus

	mm	mm	mm
INMOAB	309	80	196

4C



R Fork Seeder Plus

	mm	mm	mm
INSEAB	274	86	58

4C



R Cultivator Plus

	mm	mm	mm
INWDAB	270	78	54

4C



R Rakes Plus

	mm	mm	mm
INGRLAB	539	172	63

4C

Extra strong - ABS power!





JOIN THE NATURE
regular collection



Respana Gardening Tools Set

	← mm	↙ mm	↓ mm
INWN01	370	200	120

S411

- Scoop
- Scoop
- Fork
- Dual Head Hoe
- Hole Digger
- Soil Cup

regular



Dry Pad

	← mm	↙ mm	↓ mm
IP0720	716	348	33

S411

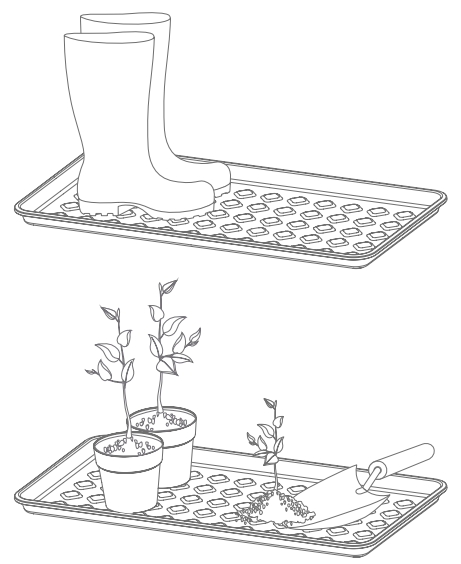

multifunctional usage





adjust the size
of the mesh

Respana Garden Sieve

	mm	mm
ISIO370M	370	104
S411		

Sturdy gardening tool, perfect for filtering stones and debris from soil. The durable and lightweight sieve is easy to use and clean.

fix size mesh 10 mm



Respana Garden Sieve

	mm	mm
ISIO370	374	104
S411		

Sturdy gardening tool, perfect for filtering stones and debris from soil. The sieve rotating by 180 degrees allows you to adjust the size of the mesh from 10 mm to 4 mm, depending on the individual needs of each user.

simple twist move
& adjust the size of the mesh
from 10 mm to 4 mm

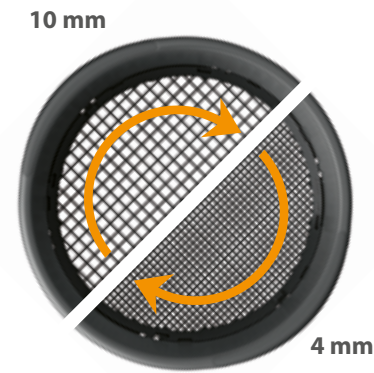

Respana Garden Sieve

	mm	mm	mm
ISIK400	394	294	108
S411			

Rectangular garden sieve, ideal for sifting large clumps of soil or compost. The sieve has an ability to adjust the size of the mesh from 10 mm to 4 mm with one simple move.

simple slide move
& adjust the size of the mesh
from 10 mm to 4 mm

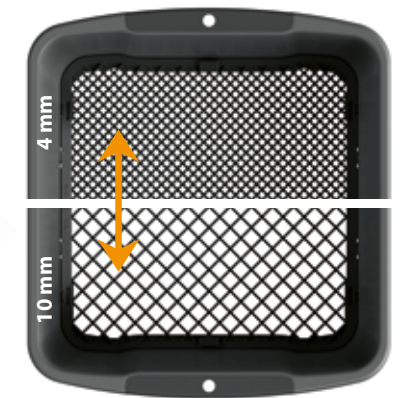







JOIN THE NATURE
regular collection



Tomato Grower

				
	mm	mm	mm	total
IPOM300	295	245	1152	12,0
IPOM400	392	315	1530	28,0

S433



Watch Video



enjoy your tomatoes



Tomato Grower

	mm	mm	mm total	
IPOM350	345	265	1270	18

S433



new size

space for watering



Compatible
with Tomato Grower
IPOM 300 / IPOM400
IDPO300/ IDPO400

Independent application kit compatible with Tomato Grower.

A pot that provides optimal conditions for growing tomato plants. The set is equipped with rings that surround the plant and stabilise the crop.



JOIN THE NATURE
regular collection



regular

Grow your gorgeous
garden with absolute ease!



Tomato Grower Cap

	mm	mm
IPOC400	385	51

S429



Compatible
with Tomato Grower
IPOM 300 / IPOM400
IDPO 300 / IDPO400



Independent application kit compatible with Tomato Grower, Home Grower.

new

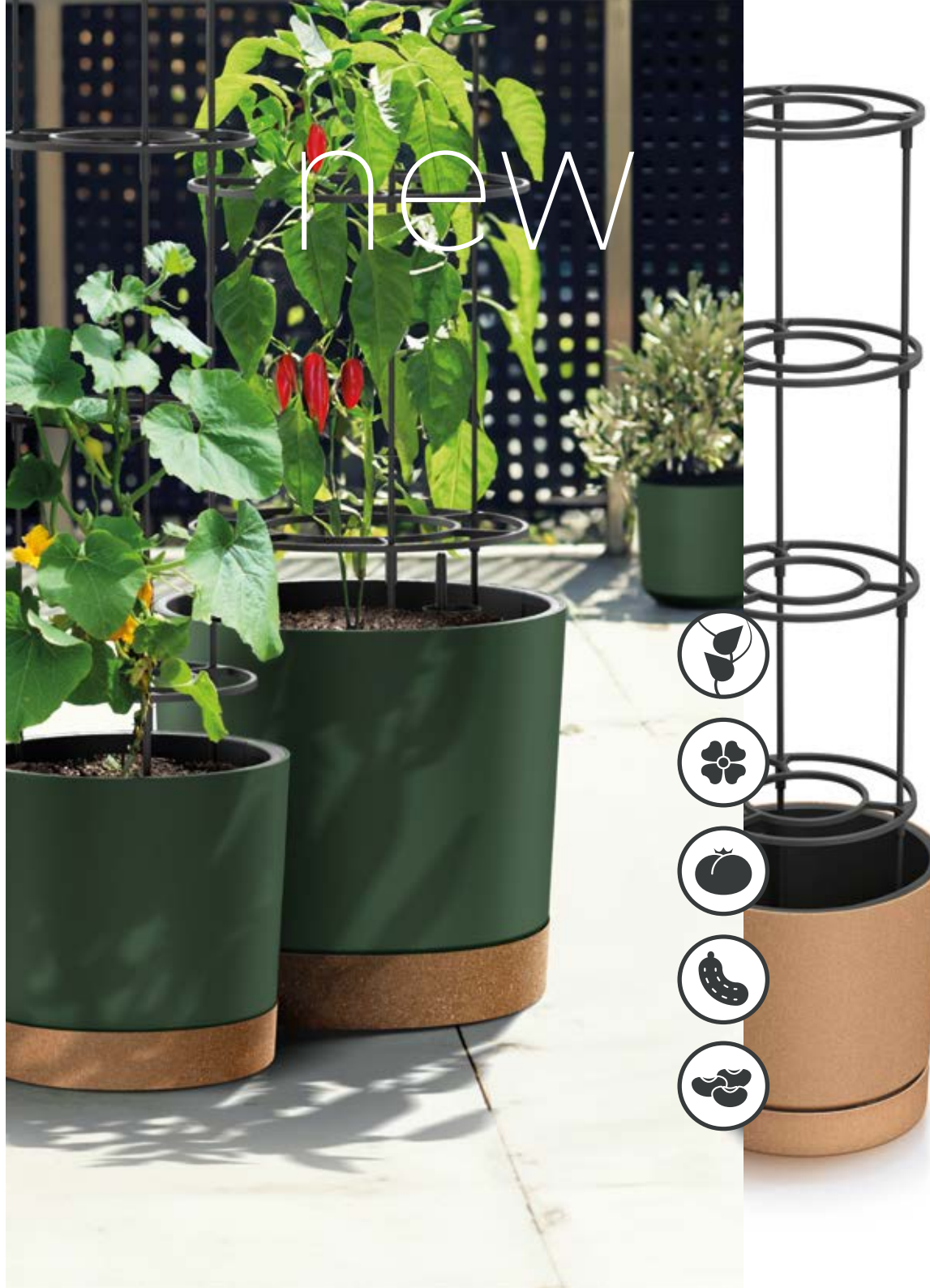

new

Home Grower

	□	∅	↑	↑ total	⊞
	mm	mm	mm	mm	
DPO300	292	283	1080	14,5	
DPO400	390	375	1415	35,0	

S433 2411U 4665W
Saucer in 4665W



**HOME
GROWER**

Home Grower is a specialized planter designed for home cultivation of climbing vegetables, fruits, and ornamental plants requiring support. With the option to disassemble the supporting structure, enabling vertical growth and optimal utilization of cultivation space. It is a unique blend of functionality with thoughtful design; the planter not only fulfills its purpose but also presents itself beautifully. Home Grower is available in two sizes and three color variations, including the ECO Wood version. The product is made from material resistant to weather conditions and solar radiation.

Compatible with Tomato Grower Cap IPOC400.







JOIN THE NATURE
regular collection

regular

enjoy your potatoes



Potato Grower

			
	mm	mm	mm
IZIE300	295	245	12,0
IZIE400	392	316	28,0

S433



Grow your gorgeous
garden with
absolute ease!

A pot that makes it possible to grow organic potatoes on your balcony. Its special design enables trouble-free harvesting of vegetables.



Plant potato bulbs
into the soil.

Keep adding
the soil.

Provide your plants with a comfortable start.

The openings at the bottom



new



new



new



Planti

	□	∅ mm	↑ mm	📄
DMLR120	125	110	0,9	
DMLR140	145	128	1,4	
DMLR160	165	146	2,1	
DMLR190	195	160	3,1	
DMLR230	235	190	5,4	



Grower

	□	∅ mm	↑ mm	📄
DOGR110	109	100	0,6	
DOGR125	124	114	1,0	
DOGR140	139	128	1,3	
DOGR160	159	146	2,0	
DOGR180	179	165	3,0	
DOGR200	199	183	4,0	
DOGR240	235	216	6,5	

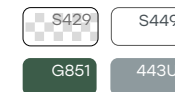

The Planti and Grower is ideal for sowing seedlings or direct seeding. It works perfectly for growing plants indoors. The openings at the bottom of the planter allow for controlled drainage of excess water. Made of durable material, it is designed for multiple uses.





JOIN THE NATURE
regular collection



F SUPPORTS FLOO

Floo Supports: Sets of various elements such as stakes, spirals, rings, crossbars, and clips that serve as support for plants in their growth. They stand out for their versatility in application, suitable for different types of plants and various locations like gardens, balconies, or patios. Functional sets offer diverse configuration options, allowing for flexible adaptation to plant needs or overall floral composition. Plant supports are easy to assemble and disassemble, allowing for independent assembly and modifications to the structure at any time. Thanks to their wide and deep anchors, they can be easily driven into the ground, providing stability for the climbing plant structure.

Elevate your plants to a higher level!

new Flo Support IFLS1

Set Contains:

8 pcs - 60 cm

16 pcs

8 pcs

4 pcs

24 pcs

8 pcs

dimensions:
~ 21 x 21 x 120 cm

1x



option

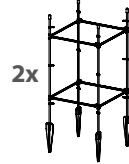

2x
dimensions:
~ 21 x 21 x 60 cm

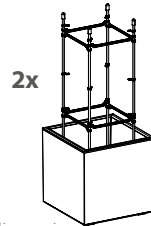

2x
dimensions:
~ 21 x 21 x 60 cm

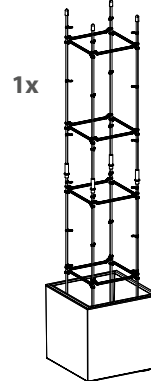

1x
dimensions:
~ 21 x 21 x 120 cm

new Flo Support IFLS2

Set Contains:

8 pcs - 60 cm

16 pcs

8 pcs

4 pcs

24 pcs

8 pcs

dimensions:
~ 29 x 29 x 120 cm

1x



option

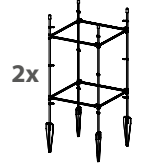

2x
dimensions:
~ 29 x 29 x 60 cm

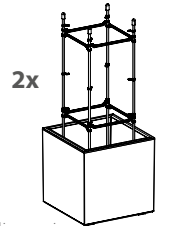

2x
dimensions:
~ 29 x 29 x 60 cm

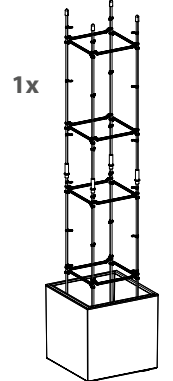

1x
dimensions:
~ 29 x 29 x 120 cm

G851

Closed structures are ideal for arrangement
in a flowerpot with dimensions of 30 x 30 cm.



Compatibility:
Sierra, Madera

G851

Closed structures are ideal for arrangement
in a flowerpot with dimensions of 40 x 40 cm.



Compatibility:
Sierra, Madera



JOIN THE NATURE
regular collection



new Floo Supports IFLS3

Set Contains:

12 pcs - 60 cm



18 pcs



18 pcs



3 pcs



36 pcs



6 pcs

dimensions:
~ 60 x 120 cm

G851

The set allows for creating one of three construction variants for plant support.

The construction will work perfectly with plants such as climbing roses, ivy, hops, clematis, sweet peas, beans, wisteria, climbing nasturtium.

1x



option

2x

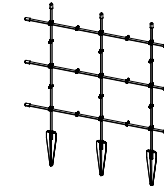

dimensions:
~ 60 x 60 cm

1x

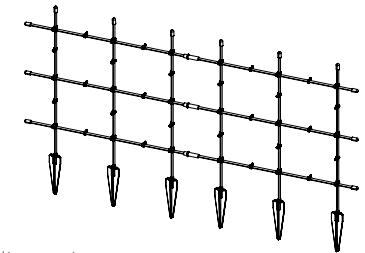

dimensions:
~ 120 x 60 cm



new
Floo Supports
IFLS4

Set Contains:

36 pcs - 60 cm



54 pcs



45 pcs



21 pcs



110 pcs



9 pcs

dimensions:
 ~ 120 x 180 cm

1x

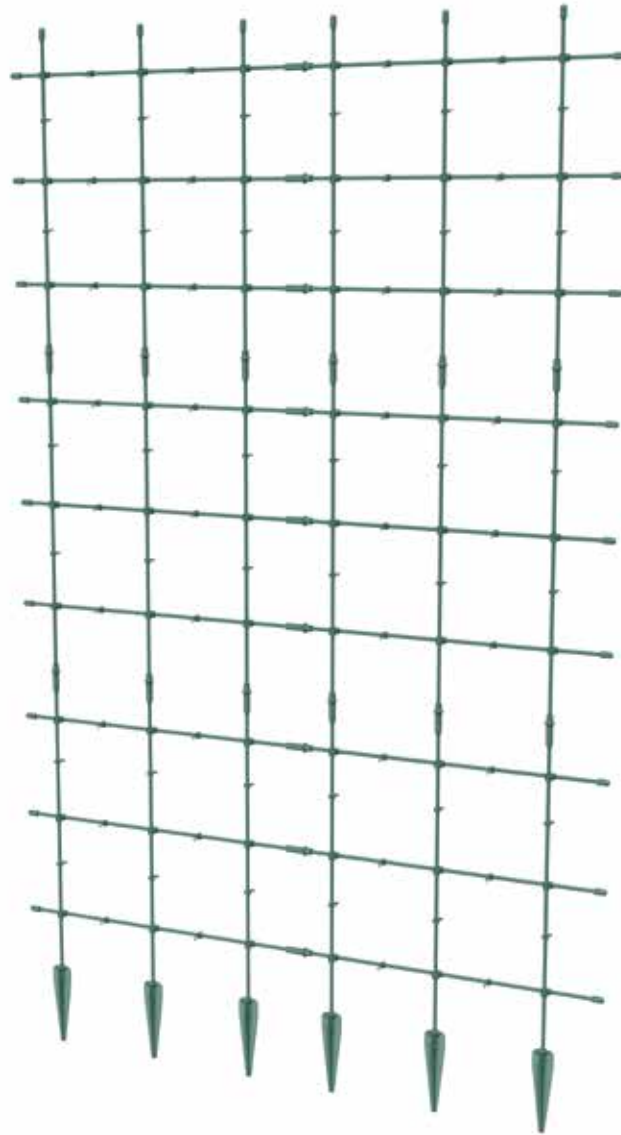

option

1x

dimensions:
 ~ 180 x 120 cm

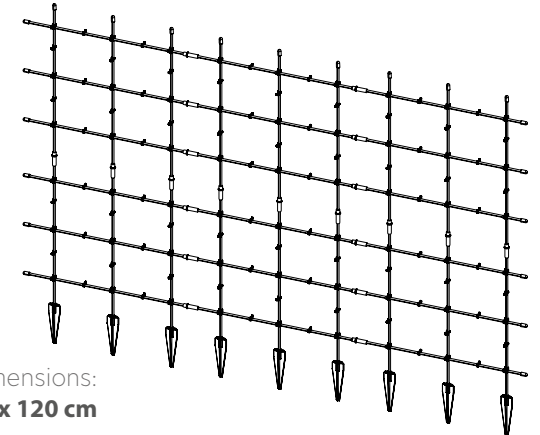

3x

dimensions:
 ~ 60 x 120 cm

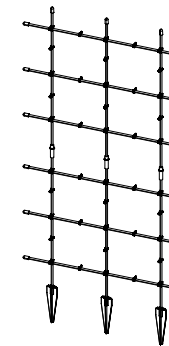

G851

The set allows for creating one of three construction variants for plant support.

The construction will work perfectly with plants such as climbing roses, ivy, hops, clematis, sweet peas, white beans, decorative peas, climbing nasturtium, wisteria, climbing hydrangea.





JOIN THE NATURE
regular collection



SUPPORTS
FLOO

new Floos Supports IFLS5

Set Contains:

4 pcs - 44 cm

4 pcs - 32 cm



2 pcs



2 pcs



2 pcs



16 pcs



3 pcs



3 pcs



6 pcs

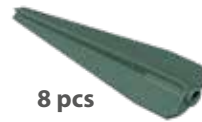

8 pcs

dimensions:
~ Ø 35 x 80 cm

G851

The set allows for creating four combinations for supporting plants. Tall combinations work perfectly for garden cultivation of tomatoes and peppers, while short combinations are ideal for ground cucumbers, strawberries, beets, and bouquets such as peonies, dahlias, zinnias, rudbeckias, campanula, garden phlox, soapwort.



1x



option

2x

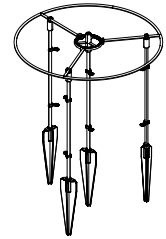

dimensions:
~ Ø 35 x 32/44 cm

1x

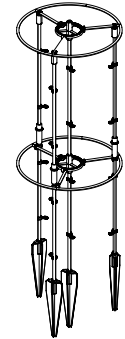

dimensions:
~ Ø 25 x 80 cm

2x

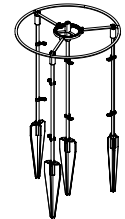

dimensions:
~ Ø 25 x 32/44 cm

Elevate your plants to a higher level!

new Floo Supports IFLS6

Set Contains:

8 pcs - 32 cm

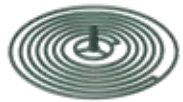

1 pc



6 pcs



10 pcs



4 pcs



1 pc



1 pcs



20 pcs



4 pcs

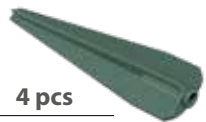

4 pcs



1x

dimensions:
~ Ø 25 x 60 cm

option

1x

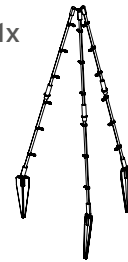

dimensions:
~ Ø 38 cm

1x



dimensions:
~ 27 x 27 cm



G851

The set allows for assembling two structures for supporting plants designed for climbing flowers, decorative floristry arrangements with low climbing roses, Mina lobata or for placing in the garden or pot without a spiral, ideal for growing beans or peas.

new Floo Supports IFLS7

Set Contains:

8 pcs - 44 cm

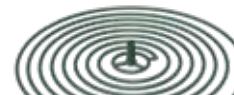

1 pc



6 pcs



15 pcs



4 pcs



1 pc



1 pcs



32 pcs



4 pcs

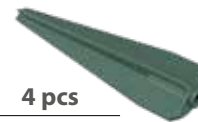

4 pcs

dimensions:
~ Ø 35 x 90 cm



1x

option

1x



dimensions:
~ Ø 50 cm

1x

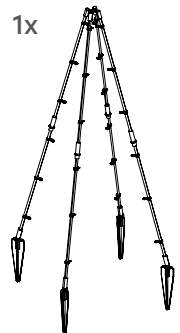

dimensions:
~ 35 x 35 cm



G851

The set allows for assembling one of the two plant-supporting structures, intended for climbing flowers, vegetables, and green plants. It works perfectly for growing white peas or for placement in the garden; in a pot without a spiral, it is ideal for growing beans or peas.



JOIN THE NATURE
regular collection

TUNNEL
FLOO



A small space, big possibilities - a green corner in your garden.



quick and easy installation



new

Floo Tunnel



IFLT1

G851



Possibility of double-sided clamping of the film sheet.



new

Floo Tunnel



IFLT2

G851



A low greenhouse for plant cultivation available in two lengths: 240 cm and 360 cm. The greenhouse features a foil with aluminum eyelets for fastening to the ground. A solution that works well for both amateur strawberry cultivation and field cultivation.



Combioliq







Make your own organic fertiliser from common garden and meadow plants



JOIN THE NATURE
regular collection

Combioliq

	 mm	 mm	 mm	
IBFT25	296	425	25,0	
IBFT55	380	590	55,0	

S411



25 l
capacity

55 l
capacity



The Combioliq tank

ensures safe storage of the preparation (in a shaded place, usually for more than one month), while the special cover design protects the liquid against insects and allows free gas exchange, which effectively eliminates the unpleasant smell of a maturing fertiliser.



Underground mini-compost bin

for turning organic matter into a natural fertiliser

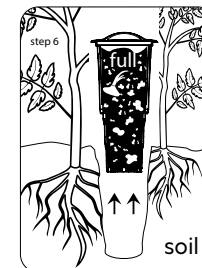
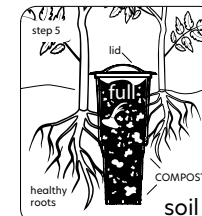
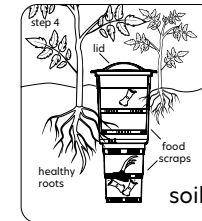
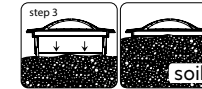
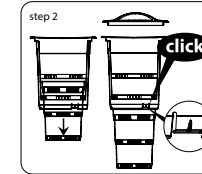
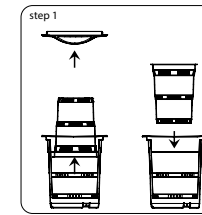

Prosperplast®
regular



Combiosoil

IKUGL	250	530	11,0

S411





JOIN THE NATURE
regular collection



Discover

watering cans
collection



new



Tubo

	mm	mm	mm	
IKT2	272	128	246	2,0

- S449
- 4985U
- 443U
- 2411U
- S433
- 446U
- 117U



Jug

	mm	mm	mm	
IKJ2	240	120	200	1,8

- S449
- 4985U
- 443U
- 2411U
- S433
- 446U
- 419U

new



Ibis

	mm	mm	mm	
IKI2	255	127	236	2,0

- S449
- 2411U
- 443U
- S433
- 446U

Jug watering can, made of durable materials. The ergonomic handle allows for comfortable carrying and the spout shape helps in directing the water stream precisely.





JOIN THE NATURE
regular collection



regular



Spry



IS006	100	215	0,6
IS012	120	245	1,2

623U S433



Eos



IKE015	291	110	222	1,5
--------	-----	-----	-----	-----

S449 623U S433



Koni



IKON2	350	110	225	1,8
IKON5	500	150	300	4,5

R200 G800 623U
S433

Koni watering can is a trusted solution designed mainly for gardening activities. With a removable spring rose. The large handle increases the comfort of use. Idoz, a very simple and functional irrigation system. Your plants can even be left unattended for a few days.





Giraffe

IKW2	← mm	↗ mm	↑ mm	L
	334	140	326	
CY728	623U	S433		



Coubi

IDUKON2	← mm	↗ mm	↑ mm	L
	313	118	306	
S449	623U	S433		



Zebra

IKZ02	← mm	↗ mm	↑ mm	L		
	352	102	224		2,0	
	IKZ05	540	140		290	5,0
	IKZ10	553	174		365	10,0
623U	S433					



Giraffe is a modern, slim watering can with a matt surface. Thanks to the special profile of its neck design don't cause overflowing.

Zebra practical watering can is a basic element of any garden or plot. The product is very light and handy, but also resistant to impact and denting. With a removable sieve. Available in three sizes – 2, 5 and 10-litre.





JOIN THE NATURE
regular collection



Aqua

	← mm	↗ mm	↑ mm	Ⓛ
IKA05	580	123	265	5,0
IKA10	650	157	360	10,0

361C



Spring

	← mm	↗ mm	↑ mm	Ⓛ
IKSP02	380	108	235	2,0
IKSP03	394	120	265	3,0
IKSP05	455	150	305	5,0
IKSP08	500	170	345	8,0
IKSP10	525	180	370	10,0
IKSP14	575	205	390	14,0

G642

new
size



Classico

	← mm	↗ mm	↑ mm	Ⓛ
IKCL05	406	185	290	5,0
IKCL10	500	230	350	10,0

B68M



Agri

	← mm	↗ mm	↑ mm	Ⓛ
IKAG75	605	160	370	7,5
IKAG100	635	180	400	10,0

S411



Spring Rose

	∅ mm	↑ mm
ISIT	51	50
ISIT1	61	60
ISIT3	104	120

S411 116C

S411

It is made of high-quality material in blow moulding technology what makes it an extremely durable design. It has a comfortable, ergonomic handle and removable, large and solid spring rose.

ISIT	Koni IKON2	Zebra IKZ02		
ISIT1	Koni IKON5		Spring IKSP03	
ISIT3		Zebra IKZ05 IKZ10	Spring IKSP05 / IKSP08 IKSP10 / IKSP14	Classico IKCL05 IKCL10



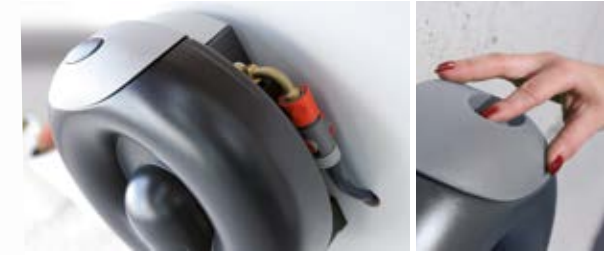

Gikabe



IGIKA	400	260	450	~7/10l	~5sec
-------	-----	-----	-----	--------	-------

S433



quick-water system

Thanks to innovative Gikabe quick-water system you don't have to waste your time on filling a bucket or watering can in a traditional way. All you have to do is press the button in the tank and the watering can or bucket will fill with water immediately.



GARDEN CELLAR

A garden cellar as an additional space for storing food, maintaining a stable, relatively low temperature.

The temperature conditions in the underground cellar make it possible to store preserves, fresh vegetables, as well as wines.

Thanks to this, the cellar provides us with measurable economic benefits, such as a significant reduction in electricity bills.

It is a great alternative for additional storage space for homeowners without a basement or pantry.

The assembly of the cellar is extremely simple and it takes about 5 hours to set it up. You need approx. 5m² of undeveloped space in your garden to install this modern dugout.

The material used in the production ensures high durability and resistance to moisture. Thanks to high tightness, it also prevents unwanted guests such as rodents from getting inside.

Gravity ventilation allows free air exchange and does not require any mechanisms to operate. Air exchange occurs under the influence of temperature differences.



new

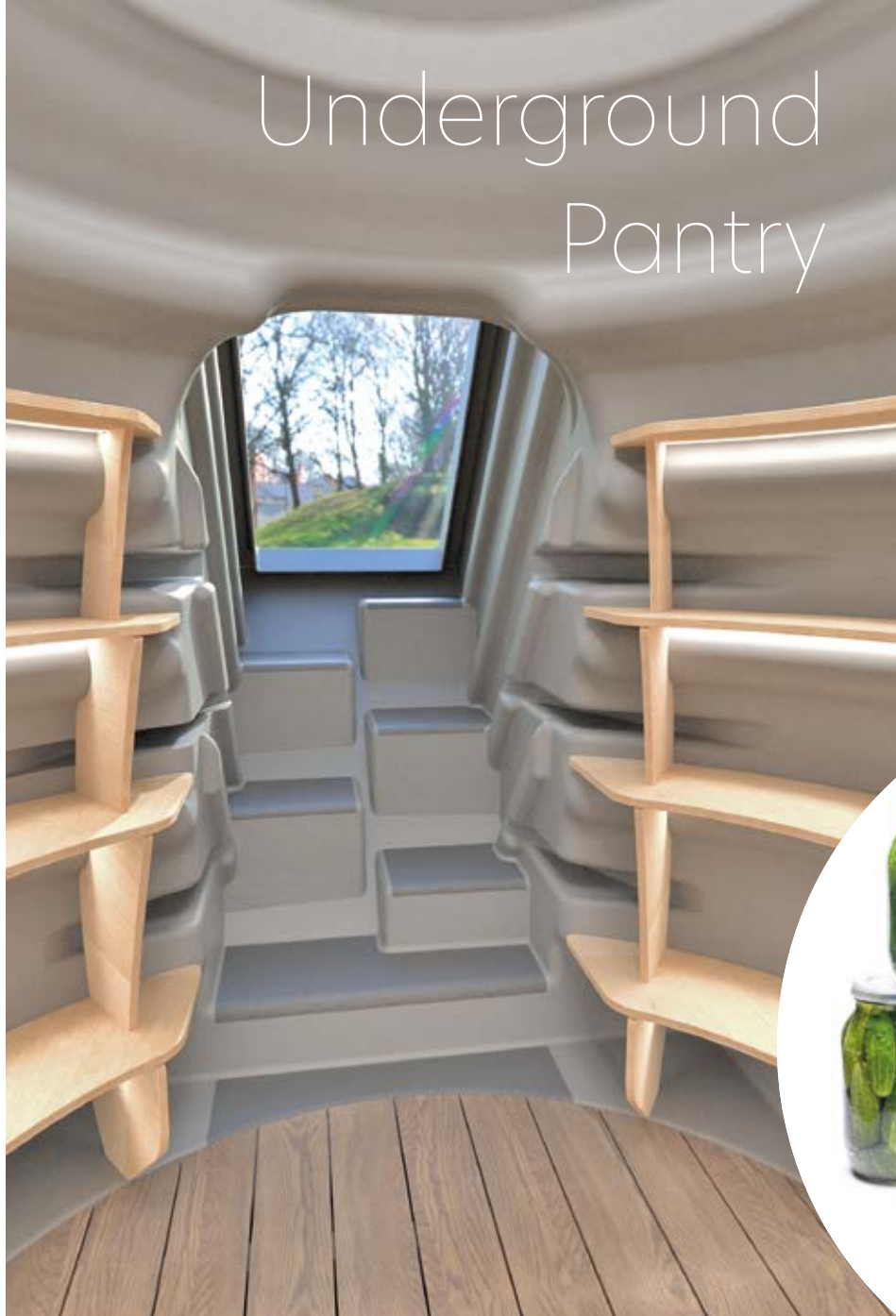

Underground Pantry



Ovo

mm	mm	mm	mm	
ROV	3570	2200	2600	7500,0

The cellar is environmentally friendly - it works without energy consumption.





JOIN THE NATURE
regular collection

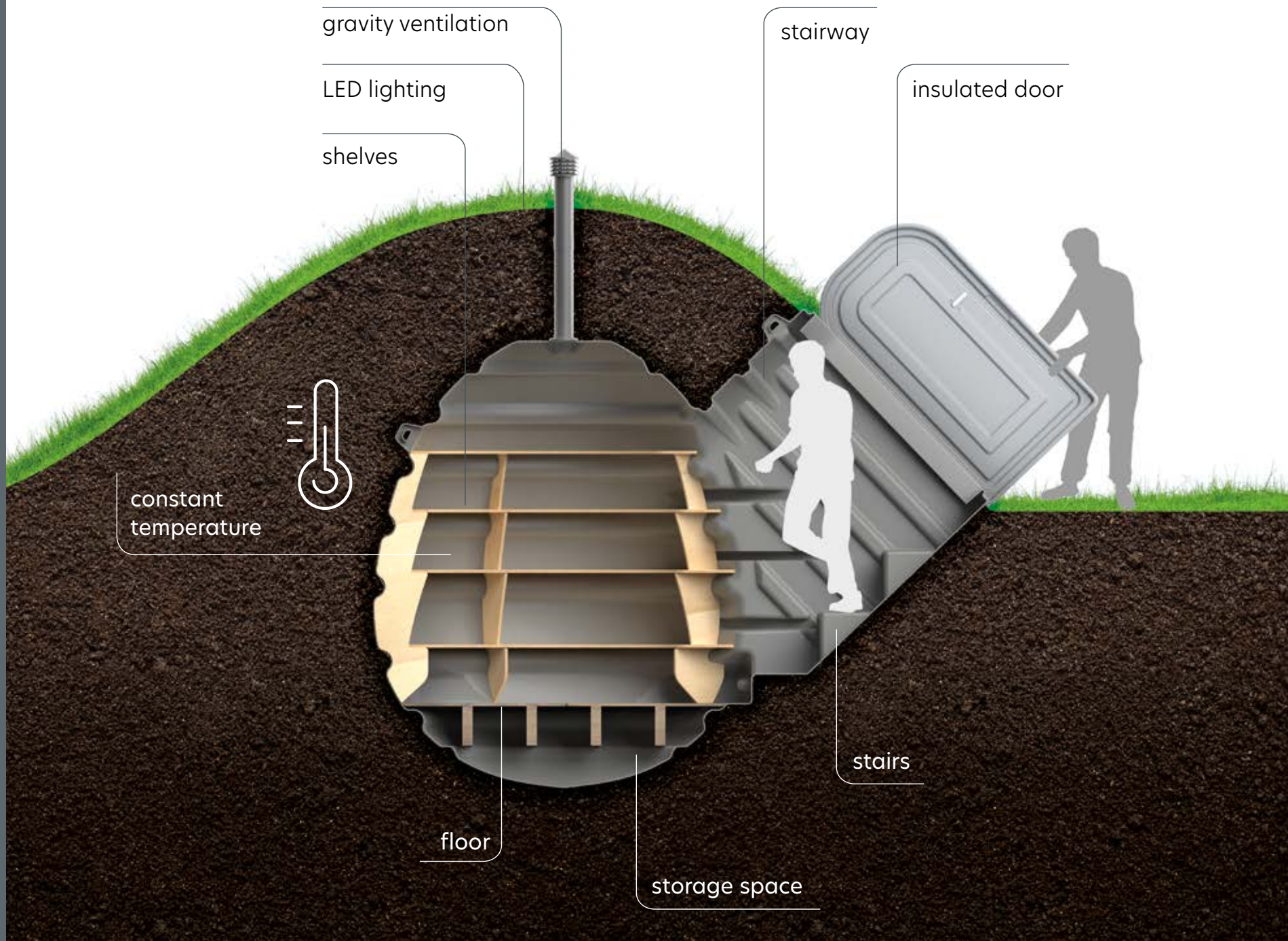

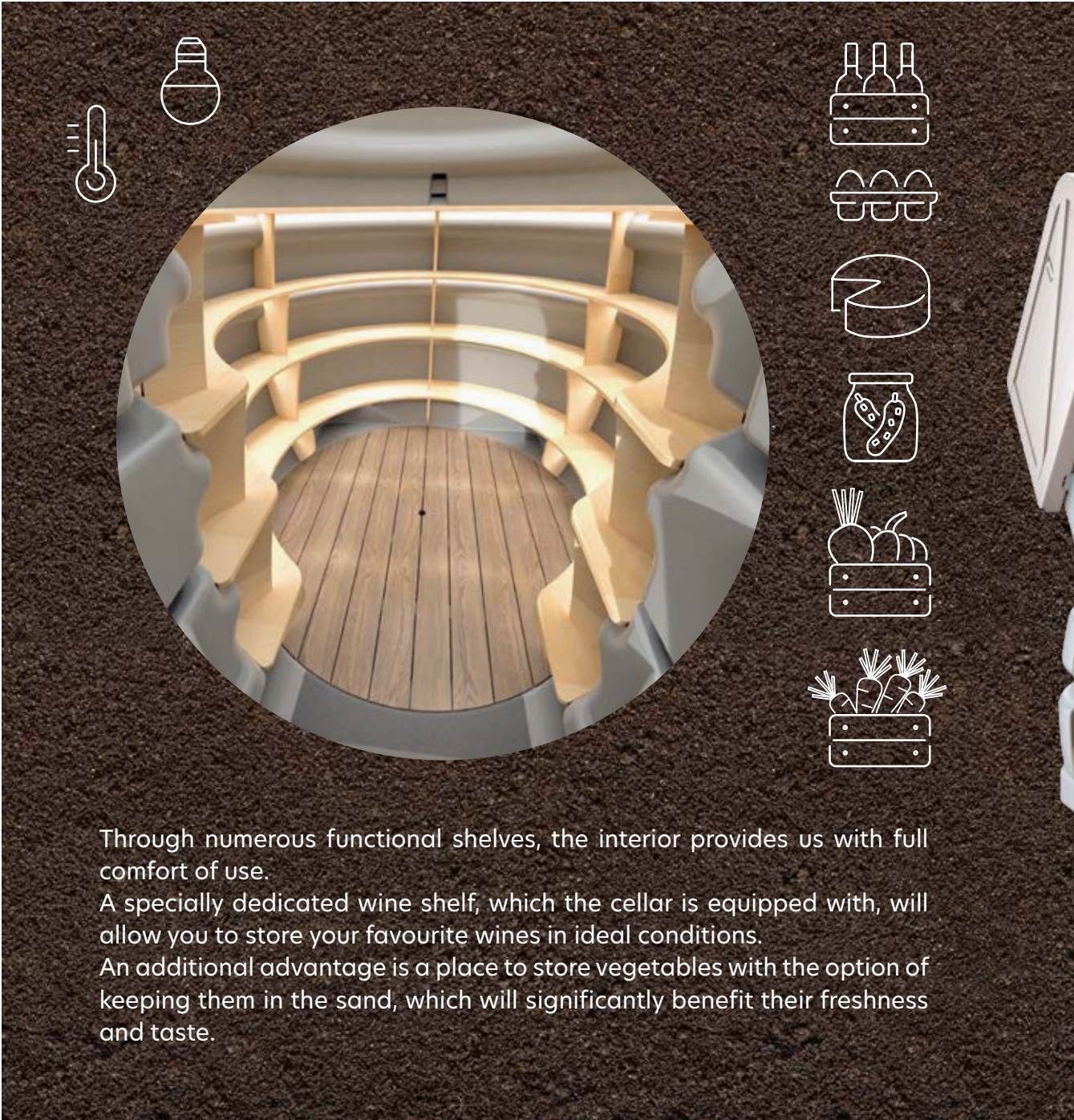

constant temperature
regardless of the season



Through numerous functional shelves, the interior provides us with full comfort of use.
A specially dedicated wine shelf, which the cellar is equipped with, will allow you to store your favourite wines in ideal conditions.
An additional advantage is a place to store vegetables with the option of keeping them in the sand, which will significantly benefit their freshness and taste.



JOIN THE NATURE
regular collection

great help
with gardening



55 l
capacity



Load&go

	← mm	↗ mm	↑ mm	Ⓛ
IW055C	500	610	840	55
IW055Z	500	610	840	55

370U S411

IW055C - black
IW055Z - green

Universal, capacious, and easy to push two-wheeled transport wheelbarrow with a lightweight stable design.



85 l
capacity



Load&go II

	← mm	↗ mm	↑ mm	Ⓛ
IW085C	790	570	715	85
IW085Z	790	570	715	85

370U S411

IW055C - black
IW055Z - green

Multifunctional usage- push & pull option.



95 l
capacity



Load&go II

	← mm	↗ mm	↑ mm	Ⓛ
IW095C	840	575	925	95
IW095Z	840	575	925	95

370U S411

IW055C - black
IW055Z - green

Thanks to its large capacity, the wheelbarrow makes it possible to transport a large amount of material at once. Very manoeuvrable thanks to reinforced rubber wheels.



regular



Solid & durable wheels



90 |
95 |
110 |
capacity



Wheeler

	mm	mm	mm	
NBWB90	583	394	783	90
NBWB95	540	496	762	95
NBWB110	540	496	852	110

S411

Wheeler is a mobile bin equipped with wheels and a handle for transportation, thanks to which it can be always where it is needed. Its tight lid isolates unpleasant smells, and a latch in the lid prevents it from being opened by the wind. The smoothly finished interior makes it easy to clean. The model is available in three sizes, so it meets the individual needs of the user.



80 |
120 |
160 |
capacity



Smooth

	mm	mm	mm	
IDSM80U	565	464	650	80,0
IDSM120U	696	594	670	120,0
IDSM160U	695	600	878	160,0

429U

S411

The Smooth bin is perfect for garden, allotment garden or office. It is made of high-quality material with high resistance to external factors. The sturdy side handles make it very easy to carry. The aesthetic lid allows you to hide the contents - it can be waste, compost, branches or rainwater. The model is available in three sizes, depending on the user's needs.



JOIN THE NATURE
regular collection



great help
with gardening



Rake Loader

	← mm	↘ mm	↑ mm
ILG2*	385	145	380

*not assembled

S411

New extraordinary design concept -
shovel and rake in one!



Bear Paw

	← mm	↘ mm	↑ mm
IGLIS1	390	70	520

*not assembled

370U

two-component
grip

aluminium
oval handle

rubber athermal
cover

regular



twist-lock
connector - easy
to assemble
& disassemble



Bear Paw leaf scoop is a perfect tool for tidying up the garden,
useful all year round. It will help you gather a large amount
of leaves or cut grass at a time, protecting your hands. The set
of hand rakes includes 2 „paws“ finished with convenient grips.





A modern, wall-mounted holder with rubber finish. Solves the problem of keeping portable tools perfectly.

Your tools will be organised.



Multi Holder



IWN1 310 98 70

405U

7 kg max



Multi Holder



IWN2 597 128 118

405U

15 kg max



Focus



IGR2 460 170 1650

R585

G642



Expert



IGR3 496 420 1820

R585

G642

S433



Expert Alu



IGR3A 496 420 1950

R585

G642

S433

An indispensable tool in every garden. Durable, perfect for removing leaves in the autumn or raking cut grass in the summer.

great help
with gardening
tools



Focus Baby



IBDG 217 155 710

361C

3005U

1788C



Load Baby



IBLD 194 198 740

361C

3005U

1788C



Load Baby Alu



IBLA 194 198 715

361C

3005U

1788C

A collection of tools created for „young gardeners“. Perfect for the sandpit or the beach.



JOIN THE NATURE
regular collection



Woodebox

	mm	mm	mm	mm
MBWL140	585	460	550	140
MBWL190	780	438	550	190
MBWL280	1160	438	550	280

440U S433

Boardebox

	mm	mm	mm	mm
MBBL190	780	433	550	190
MBBL280	1160	433	550	280

440U S433

Available in three sizes. The smaller one will perfectly fit a small space in blocks of flats – balconies, terraces.

Multifunctional Storage Woodebox | Boardebox- ideal solution to storage It's a perfect solution for keeping cushions, blankets, garden gadgets, smaller furniture or toys for children. The built-in loop for padlock gives you option to secure content inside. It is a practical storage box. Lightweight construction provides adequate ventilation and protection against rain. Pattern inspired by wood texture.





ideal storage solution



Boxe Matuba

	mm	mm	mm	
MBM310	1190	480	600	310
	440U	S433		

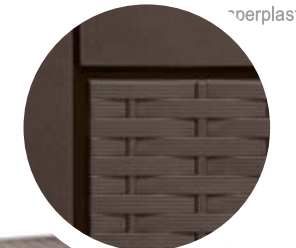

Boxe Ratio

	mm	mm	mm	
MBR310	1190	480	600	310
	440U	S433		

It is a practical storage box easy to move around thanks to the wheels. Lightweight construction provides adequate ventilation and protection against rain. Comes in 2 different panel finishes; mosaic, patterns inspired by natural woven bamboo or rattan.



Boxe Ratio Plus

	mm	mm	mm	
MBRP290	1140	470	594	290
	440U	S433		



Boxe Board

	mm	mm	mm	
MBBD290	1166	470	595	290
	440U	S433		

Boxe is a perfect solution for keeping cushions, blankets, garden gadgets, smaller furniture or toys for children. The built-in loop for padlock gives you option to secure content inside. Thanks to built-in wheels it can be easily moved around.



JOIN THE NATURE
regular collection



ideal storage solution

100% made
of recycled
material





Boxe is a perfect solution for keeping cushions, blankets, garden gadgets, smaller furniture or toys for children. The built-in loop for padlock gives you option to secure content inside. Thanks to built-in wheels it can be easily moved around.



living style



JOIN THE NATURE
regular collection





Lottie

	← mm	↙ mm	↑ mm
FLOS445	396	396	465
FLOS866	770	590	565
FLOS888	775	775	765

7535C
4193C
443U
433C



living style

Modern, versatile table suitable for outdoor and indoor decor. Designed in different sizes to provide an ability to create creative table arrangements.





JOIN THE NATURE
regular collection



regular

Uniqubo

	∅ mm	↓ mm	⊞
IKUB20	337	292	20
IKUB35	390	400	35
IKUB55	447	450	55

S433

Uniqubo

	∅ mm	↓ mm	⊞
IKUB55T	447	450	55

S433

The harmony of proportions and elegant shape make this line an ideal complement for every interior and house surroundings. They are made of a lightweight, yet durable material, easy to clean and weatherproof.





The Uniqubo Set3, Set5 multi-functional furniture set ensures high comfort of everyday use, and its components can be arranged as you like. The openwork seats and the table with a top made of natural material can perform very well in the recreational garden space, on the terrace or balcony, or in the home relaxation zone. They are made of a lightweight, yet durable material, easy to clean and weatherproof.



Uniqubo

	□	∅	↑	↓
	mm	mm	mm	mm
IKUB20T	337	292	20	
IKUB35T	390	400	35	
IKUB55T	447	450	55	

S433



Uniqubo Set 3

	□	∅	↑	↓
	mm	mm	mm	mm
IKUBS3	447	450	-	

S433



1 basket with lid 2 seats



Uniqubo Set 5

	□	∅	↑	↓
	mm	mm	mm	mm
IKUBS5	447	570	-	

S433



1 basket with lid 4 seats



JOIN THE NATURE
regular collection

living style



regular



Clubo

	Ø mm	↑ mm	↓ mm
ICLU25	335	330	25
ICLU35	386	358	35
ICLU50	450	410	50
ICLU100	590	455	100

S433

The harmony of proportions and elegant round shape make this line an ideal complement for every interior and house surroundings. They are made of a lightweight, yet durable material that is easy to clean and weatherproof. Clubo has a removable lid that allows a wide range of applications of this basket and is available individually or in a set of 2 baskets.



Clubo Set

	Ø mm	↑ mm
ICLU1S	386	358

S433



Clubo Set

	Ø mm	↑ mm
ICLU2S	450	410

S433



Clubo Set

	Ø mm	↑ mm
ICLU3S	590	455

S433



Clubo Set

	Ø mm	↑ mm
ICLU4S	590	455

S433





Clubo

	mm	mm	mm
ICLU25T	335	330	25
ICLU35T	386	358	35
ICLU50T	450	410	50
ICLU100T	590	455	100

S433



The harmony of proportions and elegant oval shape make this line an ideal complement for every interior and house surroundings. They are made of a lightweight, yet durable material that is easy to clean and weatherproof. Clubo has a removable lid that allows a wide range of applications of this basket. It is available individually or in a set of 2 baskets in different sizes and lid colours.



Clubo Set

	mm	mm
ICLU25T	386	358

S433



ICLU25T + ICLU35T



Clubo Set

	mm	mm
ICLU35T	590	455

S433



ICLU50T + ICLU100T



Clubo

	mm	mm	mm	mm
ICLUE30	440	298	375	30
ICLUE55	570	348	456	55

S433



Clubo

	mm	mm	mm	mm
ICLUE30T	440	298	375	30
ICLUE55T	570	348	456	55

S433



Clubo Set

	mm	mm	mm
ICLUE15	570	348	456

S433

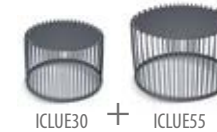

ICLUE30 + ICLUE55



Clubo Set

	mm	mm	mm
ICLUE15T	570	348	456

S433



ICLUE30T + ICLUE55T





living style



JOIN THE NATURE
regular collection



Zanzi Basket

	□	∅	↓	⌄
		mm	mm	
IKPIR 380		374	402	25
IKPIR 430		430	463	40
	7501U	S433		



regular

Zoe Basket

	□	∅	↓	⌄
		mm	mm	
IKPIO370		364	359	25
IKPIO430		419	408	40
	7501U	S433		

The harmony of proportions and elegant shape make this line an ideal complement for every interior and house surroundings. They are made of a lightweight, yet durable material, easy to clean and weatherproof.





Umbrella Base

MPOD	390	130	10,0

- S449
- 440U
- G851



Umbrella Base

MPOR	390	130	10,0

- S449
- 440U
- S433

hot and sunny days



Umbrella Base

MPKD	390	390	130	12,0

- S449
- 440U
- G851



Umbrella Base

MPKR	390	390	130	12,0

- S449
- 440U
- S433

Round and square trays for garden umbrellas which, after filling with sand or water, guarantee the stability of your sun cover. A choice of rattan or wood texture.



JOIN THE NATURE
regular collection

helpful in arranging
the garden space,
separating different
areas



Palisade



Total ~ 3,8m



A pile wall consisting of a system of modules, enabling a line of flower beds to be created in any shape.



Palisade



Total ~ 3,8m



A pile wall which helps to separate the flower beds from the lawn or stone path. Its modular design and the shape of each element enables the creation of flower-bed contours.



Palisade



Total ~ 3,02m



The convenient module connection system allows you to mould its shape freely, while the lawnmower's wheels may travel on the special flange. Perfect for example for separating the lawn from flower beds.



Palisade



Total ~ 4,05m





Palisade Border

	← mm	↑ mm
IPBO	2500	228/130

Total ~ 2,5m

R624 R222

Helpful in arranging the garden space, separating different areas. Thanks to the flexible modules and easy connections, they can be installed without tools.



Palisade

	← mm	↑ mm
IPALPLUS	2350	250/150

Total ~ 2,4m

R624 R222

A big advantage of palisade is their height which enables them to be used even in case of significantly raised terrain or particularly lush vegetation. Their structure resembles wood, which highlights the aesthetic appearance of the garden.



Palisade

	← mm	↑ mm
IPALS	2700	240/155

Total ~ 2,7m

R624 R222 405U

Palisade is very useful especially in gardens situated on uneven ground. Its height allows it to be used even in case of significantly raised terrain or particularly lush vegetation. The structure of the pin prevents its breaking during mounting.



JOIN THE NATURE
regular collection



quick and easy
installation



Garden Stone

IBST	3900	187

422U S433

Garden Palisade that allows you to quickly divide the garden or set its boundaries. It also works well for marking out garden alleys or paths in the greenhouse. The subdued colours and stone-like structure perfectly match the vegetation, concrete accessories and other garden elements.





Garden Border

	← mm	↑ mm
IBRA	3900	186,5

Total ~ 3,9m

- R624
- R222
- 405U

Garden edging which enables the garden to be divided into designated areas. Very long, flexible modules with a texture imitating rattan braid.



Garden Border

	← mm	↑ mm
IBWI	3900	186,5

Total ~ 3,9m

- R222
- 405U

Garden edging which enables the garden to be divided into designated areas. Very long, flexible modules with a texture imitating rattan braid.



Garden Fence

	← mm	↑ mm
IKRR	5950	160

Total ~ 5,9m

- R222
- G851

Garden border is particularly easy to mount, and at the same time robust and durable. The product is resistant to mechanical damage and sunlight.



Garden Line

	← mm	↑ mm
IKRA	10000	90

Total ~ 10m

- R624
- R222
- G851

The perfect solution for anybody who appreciates simplicity and convenience – can be dismantled and placed elsewhere at any time without the risk of damaging plants.

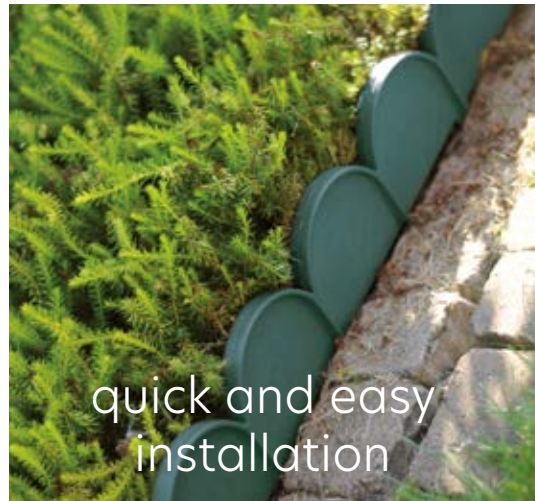

Garden Classic

	← mm	↑ mm
IPESU	3220	350

Total ~ 3,2m

- S449
- R624
- R222

Garden fence is an universal and popular product. It provides robust fencing with simple mounting. The „CLICK“ system allows you to connect individual elements easily.



Garden Classic

	← mm	↑ mm
IPESU2	3600	520

Total ~ 3,5m

- S449
- R624
- R222

The „CLICK“ system allows you to connect individual elements easily.



Drab

	← mm	↑ mm
IDR1	160	380
IDR2	183	500
IDR3	185	560
IDR4	200	670

- R222
- S433

The „Drab“ flower stand will support flimsy, fragile plants.



JOIN THE NATURE
regular collection

quick and easy installation





quick and easy installation

A durable and functional garden bed that can also be used as a raised bed. Resistant to damage, changing temperatures and UV radiation. The combination of several elements upwards creates comfortable and ergonomic flowerbeds adapted to the environment.



Base Woody

	← mm	↗ mm	↑ mm
IBWS	756	756	250
7587U	S433	4665W	



Base Woody

	← mm	↗ mm	↑ mm
IBWR	1492	756	250
7587U	S433	4665W	



Base Woody

	← mm	↗ mm	↑ mm
IBWH	1480	1290	250
7587U	S433	4665W	



JOIN THE NATURE
regular collection



step 1



step 2



step 3



step 4



step 5



step 6



step 7



step 8



step 9



step 10



step 11



step 12



Border 0645

	mm	mm	mm
IB0645	4800	84	45

Total ~ 4,8m

S411

Thanks to the edges, you can designate and restrict any shapes of paths made of gravel or chippings, for example for pedestrians or bicycles in parks and green areas. It can also be successfully used to separate a lawn from arable land. Quick and easy installation.





Border 1045

	mm	mm	mm
IB1045	8000	84	45

Total ~ 8m

S411



Border 1057

	mm	mm	mm
IB1057	8000	84	57

Total ~ 8m

S411

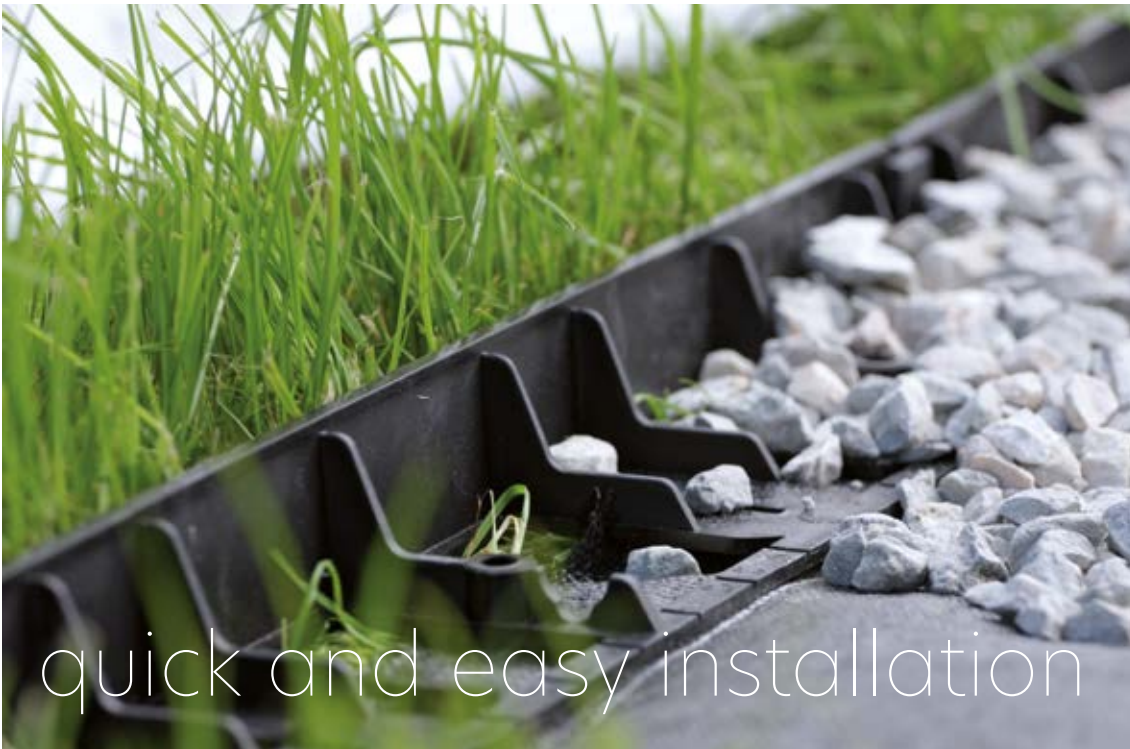

Harpoon Peg 120

	mm	mm	mm
IHR12050	44	37	125

S411



Harpoon Peg 200

	mm	mm	mm
IHR20050	67	38	209

S411



Pins (anchors) with tips for attaching edging, agrotextiles and geogrids to the ground.



JOIN THE NATURE
regular collection



universal product use



Sharkie

	mm	mm	mm	
ISSS	95	290	65	0,7

G642 B333



Sharkie you to dose the spread product accurately. In the winter, it lets you spread salt and sand, while in the summer it is perfect for seeds and fertilizer.

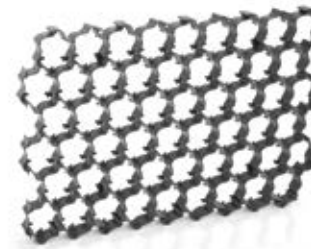

Plant

	mm	mm	mm
IKP2C	600	400	33
IKP2C1	600	400	33

S411

Plant paving panels will reinforce any ground – the lawn, driveway, parking space – and protect it against damage.



Pad

	mm	mm	mm
IKRT1	600	200	25

Total 0,95m²

R222

Panels is a universal product with unlimited potential uses. It protects the surface against damage, scratches, moisture etc. Useful on uneven areas – any items placed on its surface will be more stable. Individual modules can be easily connected and disconnected.



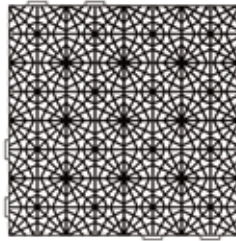

Mosaic

	← mm	↘ mm	↑ mm
IAK401	397	397	10

can be used as a composter bottom

S411



Mosaic Edge

	← mm	↘ mm	↑ mm
IOL40	380	50	10

S411

Simple and very easy-laid tiles to suit the area close to the swimming pool, balcony, lawn or garage. Thanks to easy assembly it allows to arrange any surface on the flat ground. Wide range of applications allows for example for quick assembling of a comfortable floor.

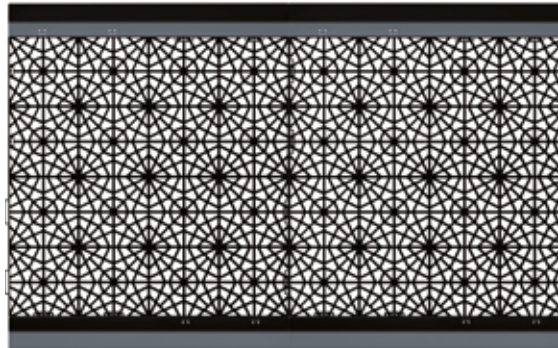

Openwork design
allows
free drainage

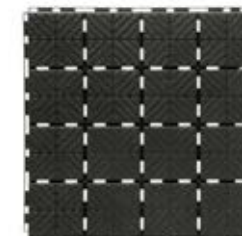

Easy Square

	← mm	↘ mm	↑ mm
IES40	400	400	20

Total 1,5m²

S411



Panels is a universal product with unlimited potential uses. It protects the surface against damage, scratches, moisture etc. Useful on uneven areas – any items placed on its surface will be more stable. Individual modules can be easily connected and disconnected.





JOIN THE NATURE
regular collection



new
quick
and easy
installation



new
Compobox

mm mm mm

IKCB310 720 715 766 310,0

S411

new
Compobox

mm mm mm

IKLC310C 720 715 766 310,0

S411

new
Compobox

mm mm mm

IKCB350 735 733 816 350,0

S411

new
Compobox

mm mm mm

IKLC350C 735 733 816 350,0

S411

Compobox is a compact and easy-to-assemble compost bin composed of modules that can be put together quickly without the need for tools. The top module features a large opening for depositing organic waste, closed with a cover secured by a special padlock included in the set. This feature ensures that the compost bin is protected from accidental opening by wind or animals. The bottom module contains two slides for convenient removal of compost. All modules feature numerous holes providing proper airflow and enabling moisture for effective decomposition of organic matter. The lower part of the compost bin is stabilized on the ground with 4 pegs. The pegs and padlock are attached to the underside of the cover during sale.



JOIN THE NATURE
regular collection



new

quick
and easy
installation



Evogreen Vario

IKEV450C	915	950	830	450,0
----------	-----	-----	-----	-------

S411

Evogreen Vario

IKEL450C	915	950	830	450,0
----------	-----	-----	-----	-------

S411

Evogreen Vario

IKEV750C	915	950	1200	750,0
----------	-----	-----	------	-------

S411

Evogreen Vario

IKEL750C	915	950	1200	750,0
----------	-----	-----	------	-------

S411

Evogreen Vario

IKEV1050C	915	950	1570	1050,0
-----------	-----	-----	------	--------

S411

Evogreen Vario

IKEL1050C	915	950	1570	1050,0
-----------	-----	-----	------	--------

S411

Segment compost bins Evogreen Vario. It combines all the benefits of the traditional Compogreen compost bin with enormous efficiency. Practical and ecological solution for gardens and agricultural plots of large areas.



JOIN THE NATURE
regular collection



new

quick
and easy
installation



Compogreen Vario

mm mm mm

IKST650C 915 950 870 650,0

S411

Compogreen Vario

mm mm mm

IKL650C 915 950 870 650,0

S411

Compogreen Vario

mm mm mm

IKST950C 915 950 1240 950,0

S411

Compogreen Vario

mm mm mm

IKL950C 915 950 1240 950,0

S411

Compogreen Vario

mm mm mm

IKST1250C 915 950 1610 1250,0

S411

Compogreen Vario

mm mm mm

IKL1250C 915 950 1610 1250,0

S411

Easy to assemble composter consisting of modules, which allows for quick assembly without the use of tools. Equipped with an ergonomic lid and bottom sliders, it ensures convenient filling of organic residues and easy compost removal.



JOIN THE NATURE
regular collection

perfect for producing
compost



regular



Compostgreen Woody

	mm	mm	mm	
IKST280	596	600	815	280,0
easy to join Mosaic				
S433				

Compostgreen Woody

	mm	mm	mm	
IKL280	596	600	815	280,0
easy to join Mosaic				
S433				

Compost bin. It is perfect for producing compost yourself. Easy to assembly and resistant to damage. Its closed form prevents animals from accessing waste products stored inside, while small holes enable air circulation. The moveable flap at the bottom allows the ready fertilizer to be taken out easily to facilitate fertilization on an ongoing basis.



Compostgreen

	mm	mm	mm	
IKST200C	610	610	753	220,0
IKST320C	700	700	800	320,0
S411				

Compostgreen

	mm	mm	mm	
IKL200C	610	610	753	220,0
IKL320C	700	700	800	320,0
S411				





Compgreen

	mm	mm	mm	
IKST380C	719	719	826	380,0

S411

Compgreen

	mm	mm	mm	
IKL380C	719	719	826	380,0

S411

Compgreen compost bin of 380l capacity, designed for composting various types of biodegradable waste and producing natural fertilizer. Thanks to the moveable gate valve we can easily access the ready fertilizer at the bottom of the tank.



Biocompo

	mm	mm	mm	
IKBI500C	1018	1018	844	500,0

S411

Biocompo

	mm	mm	mm	
IKBI900C	1146	1146	1165	900,0

S411

Biocompo compost bin. It is perfect for producing compost yourself. Easy to assembly and resistant to damage. Its closed form prevents animals from accessing waste products stored inside, while small holes enable air circulation. The moveable flap at the bottom allows the ready fertilizer to be taken out easily to facilitate fertilization on an ongoing basis.



Segment compost bins Module Compogreen. It combines all the benefits of the traditional Compogreen compost bin with enormous efficiency. Practical and ecological solution for gardens and agricultural plots of large areas.



JOIN THE NATURE
regular collection



Module compogreen



IKSM800C 1350 719 826 800,0

S411



Module compogreen



IKSM1200C 1980 719 826 1200,0

S411



Module compogreen



IKSM1600C 2610 719 826 1600,0

S411



Module compogreen



IKLM800C 1350 719 826 800,0

S411



Module compogreen



IKLM1200C 1980 719 826 1200,0

S411



Module compogreen



IKLM1600C 2610 719 826 1600,0

S411





Compost bin from the Evogreen line. The lid of the bin is equipped with a metal bar hinge and a convenient handle for opening. Evogreen is characterised by its convenient and stable structure and proven resistance to mechanical damage and adverse weather conditions. The small holes enable constant air circulation.

Evogreen



	mm	mm	mm	mm
IKEV420C	885	885	800	420,0

S411



Evogreen



	mm	mm	mm	mm
IKEV630C	900	910	1070	630,0

S411



Evogreen



	mm	mm	mm	mm
IKEV850C	900	910	1345	850,0

S411



Evogreen



	mm	mm	mm	mm
IKEL420C	885	885	800	420,0

S411



Evogreen



	mm	mm	mm	mm
IKEL630C	900	910	1070	630,0

S411



Evogreen



	mm	mm	mm	mm
IKEL850C	900	910	1345	850,0

S411





JOIN THE NATURE
regular collection



regular



Compothermo

	mm	mm	mm	L
IKB340	800	800	870	340,0
G851				

Compothermo

	mm	mm	mm	L
IKB900	1010	1010	1280	900,0
G851				

The double walls and lid ensure the perfect insulation and the optimum temperature, which makes Compothermo very efficient. Equipped with a convenient handle for closing the lid, and moveable flaps at the bottom, which provide constant to the ready fertilizer.

ideal for beginners

Ecocompo is a small, simple compost bin, ideal for beginners. It is water-tight and robust. The closed form prevents animals from accessing waste products stored inside, and the moveable flap at the bottom allows the ready fertilizer to be taken out easily to facilitate fertilization on an ongoing basis.



Ecocompo

	mm	mm	mm	L
IKEC0340	780	1040	340,0	
S411				





Onion

	∅ mm	↑ mm	l
IKCE1	200	57	1,0
IKCE2	230	64	1,2
IKCE3	260	70	1,4

G642



Onion II

	∅ mm	↑ mm	l
IKCS215	215	54	
IKCS265	265	56	
IKCS315	315	56	

G851

Onion is a practical, multifunctional basket, perfect for storing fruit, vegetables, bulbs and seedlings. Light and durable.

Onion II - Is another variation of the trusted Onion basket, whose special design enables you to stack several containers on top of each other, which lets you save space while storing bulbs or seedlings. Light and resistant to damage.

multilevel storing



IPKOSZ60

IKOSZ60

Cage

	∅ mm	↑ mm	l
IPKOSZ60	465	90	-
IKOSZ60	450	466	60,0

G851

Cage is a large 60-litre basket with a lid useful in the garden or at your plot to collect leaves, grass, fruit and others. Spacious and very light.



Billy

	∅ mm	↑ mm	l
IPBI340	338	256	15,0
IPBI420	423	318	30,0
IPBI480	482	362	45,0

389U

S411



Bucket

	∅ mm	↑ mm	l
KBU12L	310	240	12,0
KBU16L	340	255	16,0
KBU20L	365	280	20,0

S411



Durable and multi-purpose containers. Irreplaceable for planting, transferring and storage, helpful both at home and in the garden.





JOIN THE NATURE
regular collection



Birdyfeed Round

	mm	mm	mm
IBFR	294	258	122

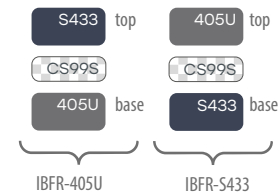

A bird feeder with a large container for grain of various sizes. The angled, round roof protects the food from rain and snow. It can be hung on a tree or attached to a balustrade or a branch with a plastic clamp. Its design also allows it to be placed on a stake.

regular

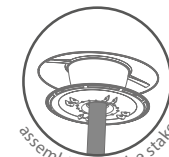
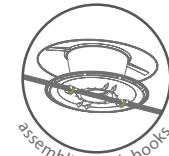



Birdyfeed Square

	mm	mm	mm
IBFS	248	182	174

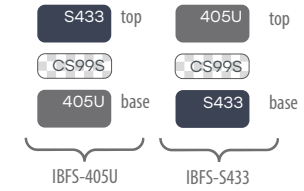

Prosperplast®
regular



The improved design means that, when you do need to fill them, it's really easy. It has a large food storage for birdseed that can be poured through a hole in the roof. The original, streamlined shape will be an ideal decoration of any garden or balcony. It can be hung on a tree or attached using a tie cord strap to a balustrade or branch. The design also allows it to be placed on pile in the straight forward position anywhere in the garden.

with concern for the welfare of animals



Birdyfeed Double

	mm	mm	mm
IBFD	280	185	173

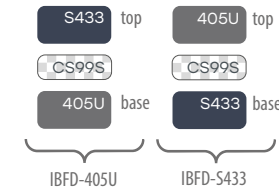

An extremely decorative, two-chamber bird feeder. The sloping roof protects the food and birds from rain and snow. It can be installed on a balcony railing or attached to a tree branch using a plastic clamp. Equipped with a string for suspending.

over 90 countries worldwide

Prosperplast
in the world



Constantly launching an innovative, diversified and high quality products and being a reliable partner, we managed to succeed on the market in different parts of the world.

Currently our products are successfully distributed to more than 90 countries worldwide and the number of satisfied customers is increasing each year!

sales
growth

1993

2024

Wszystkie prawa zastrzeżone przez Prosperplast 1 Spółka z o.o., a zawartość nie może być powielana, pobierana, rozpowszechniana, publikowana lub przekazywana w jakiegokolwiek formie i w jakikolwiek sposób, bez uprzedniej pisemnej zgody Prosperplast 1 Spółka z o.o. Niniejszy katalog nie stanowi oferty w rozumieniu obowiązujących przepisów. Za błędy w druku nie odpowiadamy.

All rights are reserved by Prosperplast 1 Spółka z o.o. and content may not be reproduced, downloaded, disseminated, published, or transferred in any form or by any means, except with the prior written permission of Prosperplast 1 Spółka z o.o. This catalogue does not constitute an offer within the meaning of applicable rules. We are not responsible for printing errors.

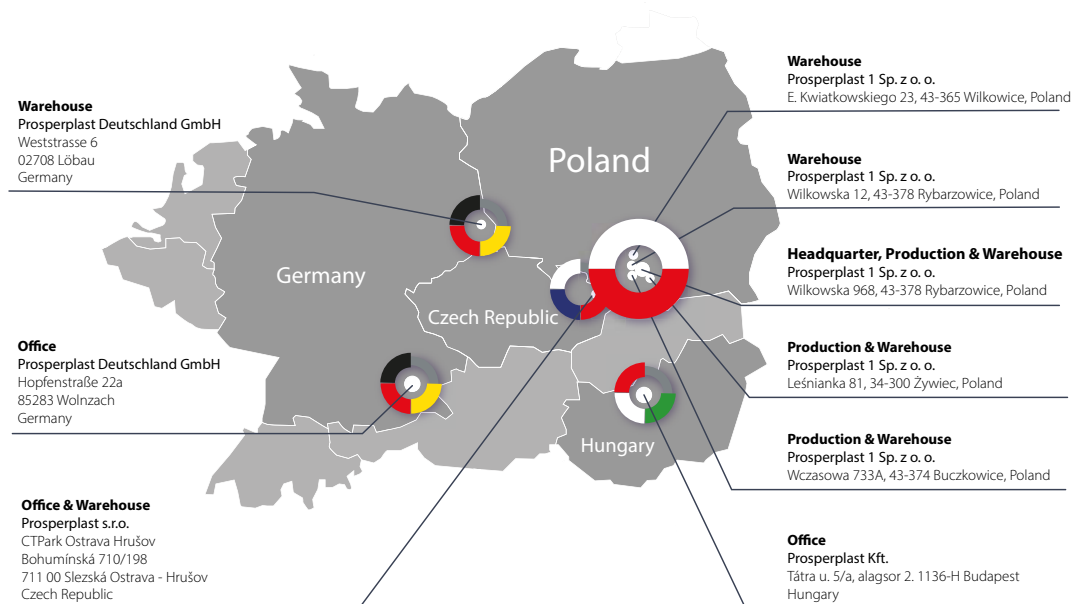

Contact us



Headquarter, Production & Warehouse

Prosperplast 1 Sp. z o.o.
Wilkowska 968
43-378 Rybarzowice
Poland

tel. +48 33 817 70 03
fax +48 33 817 60 81

biuro@prosperplast.pl
office@prosperplast.pl
www.prosperplast.pl



Office

Prosperplast Deutschland GmbH
Hopfenstraße 22a
85283 Wolnzach
Germany

tel. +49 8442 9628499
fax +49 8442 9680853

kontakt@prosperplast.de
www.prosperplast.de



Office & Warehouse

Prosperplast s.r.o.
CTPark Ostrava Hrušov
Bohumínská 710/198
711 00 Slezská Ostrava - Hrušov
Czech Republic

tel. +420 553 034 443
mob +420 605 499 544

info@prosperplast.cz
www.prosperplast.cz



Office

Prosperplast Kft.
Tátra u. 5/a, alagsor 2.
1136-H Budapest,
Hungary

tel. +36 30 4095 120
mob +36 30 4095 710

office@prosperplast.hu
www.prosperplast.hu

Prosperplast®

Prosperplast 1 Sp. z o.o.
Wilkowska 968
43-378 Rybarzowice
Poland

Feel free to place your order via B2B